



YAMAHA

XT600

OWNER'S MANUAL

Printed in Japan

2KF-28199-80

E

IDENTIFICATION NUMBERS RECORD**1. KEY NUMBER:****2. FRAME NUMBER AND ENGINE NUMBER:**

Your key identification number is stamped on your key as shown in the following illustration. Record this number in the space provided for reference if you need a new key.

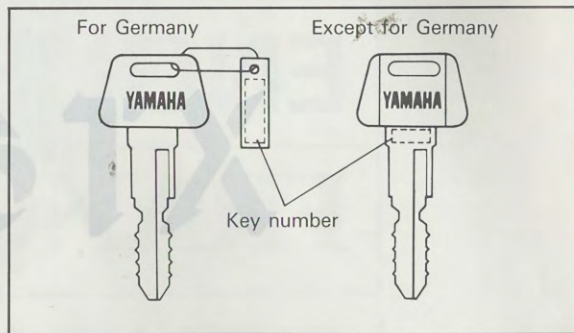

Record your frame and engine number in the spaces provided to assist you in ordering spare parts from your Yamaha dealer or for reference in case your vehicle is stolen. (See page 2-1)

WARNING:

Some data in this manual may become dated due to future improvement on this model. If you have any questions about this manual or your motorcycle, please consult a Yamaha dealer.

Particularly important information is distinguished by the following:

TECHNICAL PUBLICATIONS SERVICE DIVISION

MOTORCYCLE OPERATIONS

YAMAHA MOTOR CO., LTD.

A-001

CAUTION:

A CAUTION indicates special procedures to be followed to avoid injury to the motorcycle operator or person inspecting or working on the motorcycle.

WARNING:

A WARNING indicates special procedures to be followed to avoid injury to the motorcycle operator or person inspecting or working on the motorcycle.

INTRODUCTION

This manual should be considered a permanent part of your purchase of the Yamaha XT600. This model is the result of Yamaha's vast experience in the production of fine sporting touring, and pacetting racing machines. It represents the high degree of craftsmanship and reliability that have made Yamaha a leader in these fields.

The manual will give you an idea of the operation and basic maintenance of this motorcycle. If you have any questions about the operation or maintenance of your motorcycle, please consult a Yamaha dealer.

WARNING:

A WARNING indicates special procedures to be followed to avoid injury to the motorcycle operator or person inspecting or working on the motorcycle.

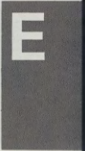

XT600
OWNER'S MANUAL
©1987 by Yamaha Motor Co., Ltd.
1st Edition, February 1987
All rights reserved. Any reprinting or unauthorized use without the written permission of Yamaha Motor Co., Ltd. is expressly prohibited.
Printed in Japan

INTRODUCTION

E Congratulations on your purchase of the Yamaha XT600. This model is the result of Yamaha's vast experience in the production of fine sporting, touring, and pacesetting racing machines. It represents the high degree of craftsmanship and reliability that have made Yamaha a leader in these fields.

This manual will give you an understanding of the operation, inspection, and basic maintenance of this motorcycle. If you have any questions about the operation or maintenance of your motorcycle, please consult a Yamaha dealer.

NOTE:

Some data in this manual may become outdated due to future improvement on this model. If you have any questions about this manual or your motorcycle, please consult a Yamaha dealer.

**TECHNICAL PUBLICATIONS
SERVICE DIVISION
MOTORCYCLE OPERATIONS
YAMAHA MOTOR CO., LTD.**

Printed in Japan
is expressly prohibited.
permission of Yamaha Motor Co., Ltd.
unauthorized use without the written
All rights reserved. Any reprinting or
1st Edition, February 1987
©1987 by Yamaha Motor Co., Ltd.
OWNER'S MANUAL
XT600

WARNING:

PLEASE READ THIS MANUAL CAREFULLY AND COMPLETELY BEFORE OPERATING THIS MOTORCYCLE.

Particularly important information is distinguished in this manual by the following notations:

NOTE:

A NOTE provides key information to make procedures easier or clearer.

CAUTION:

A CAUTION indicates special procedures that must be followed to avoid damage to the motorcycle.

WARNING:

A WARNING indicates special procedures that must be followed to avoid injury to a motorcycle operator or person inspecting or repairing the motorcycle.

NOTE:

This manual should be considered a permanent part of this motorcycle and should remain with it even if the motorcycle is subsequently sold.

WARNING:

Certain components used in the construction of this machine contain asbestos. Asbestos may be found in brake shoes, brake pads, gaskets, clutch plates and heat insulators. Breathing asbestos dust is hazardous to health. When servicing parts containing asbestos, always work in a well ventilated place, and be sure to obtain service manual and read the instructions and warnings very carefully.

E

! THINK OF YOUR SAFETY:

Both motorcycles and mopeds are fascinating vehicles which give a tremendous feeling of freedom to their riders.

They must be correctly maintained at all times in order to ensure optimum performance. However, as a rider you must also ensure that your physical condition is good, and that you are not tired, in order that you too can optimise your vehicle control. Medicines, drugs and alcohol should not be combined with riding, especially alcohol which increases the individual's likelihood of taking risks.

Alcohol is dangerous, even in small quantities:

Correct protective riding gear is just as much a part of motorcycling safety as the safety belt is in the car; a good leather suit and gloves, sturdy boots and a good quality, properly fitting crash helmet are ideal. But beware: good protective clothing can result in the individual being lulled into a false sense of security. When this happens more risks are taken and speeds increase... this particularly applies in wet weather.

The good motorcyclist therefore rides defensively and protectively in order to minimise risks.

E

CONTENTS

DESCRIPTION	1-1
MOTORCYCLE IDENTIFICATION	2-1
Frame serial number	2-1
Engine serial number	2-1
CONTROL FUNCTIONS	3-1
Main switch	3-1
Indicator lights	3-2
Speedometer	3-3
Tachometer	3-3
Handlebar switches	3-4
Clutch lever	3-5
Change pedal	3-5
Front brake lever	3-5
Rear brake pedal	3-5
Fuel tank cap	3-6
Fuel cock	3-6
Starter knob	3-7
Kick starter	3-8
Steering lock	3-8
Helmet holder	3-10
Front forks	3-11

Rear shock absorber	3-11
Sidestand	3-11
Sidestand switch operation check ...	3-12
PRE-OPERATION CHECKS	4-1
Brakes	4-3
Brake fluid leakage	4-3
Clutch	4-4
Throttle grip	4-4
Engine oil	4-4
Chain	4-5
Tires	4-5
Wheels	4-8
Fittings/Fasteners	4-8
Lights and signals	4-8
Switches	4-8
Battery	4-8
Fuel	4-9
OPERATION AND IMPORTANT	
RIDING POINTS	5-1
Starting and warming up a cold engine	5-2
Starting a warm engine	5-4

Shifting	5-5	Inspecting the brake fluid level	6-20
Engine break-in	5-6	Brake fluid replacement	6-21
Parking	5-7	Clutch adjustment	6-22
PERIODIC MAINTENANCE AND		Free play adjustment	6-22
MINOR REPAIR	6-1	Drive chain slack check	6-23
Tool kit	6-1	Drive chain slack adjustment	6-24
Periodic maintenance/lubrication	6-3	Drive chain lubrication	6-25
Torque specifications	6-5	Cable inspection and lubrication	6-25
Engine oil	6-6	Throttle cable and grip lubrication	6-26
Fuel cock cleaning	6-9	Brake and change pedals	6-26
Air filter	6-10	Brake and clutch levers	6-26
Carburetor adjustment	6-12	Sidestand	6-26
Idle speed adjustment	6-12	Rear suspension	6-27
Throttle cable adjustment	6-13	Front fork oil change	6-27
Valve clearance adjustment	6-15	Front fork and rear shock absorber	
Decompression cable adjustment	6-15	adjustment	6-31
Spark plug inspection	6-16	Rear shock	6-33
Front brake adjustment	6-17	Rear shock absorber adjustment	6-33
Rear brake adjustment	6-18	Recommended combinations of the	
Brake light switch adjustment	6-19	front fork and rear shock absorber	
Checking the front and rear brake		settings	6-36
pads	6-19	Steering inspection	6-37

Wheel bearings	6-37
Battery	6-37
Replenishing the battery fluid	6-39
Fuse replacement	6-40
Replacing the headlight bulb	6-41
Headlight beam adjustment	6-43
Front wheel removal	6-44
Front wheel installation	6-45
Rear wheel removal	6-47
Rear wheel installation	6-48
Troubleshooting	6-49
Troubleshooting chart	6-50
CLEANING AND STORAGE	7-1
A. Cleaning	7-1
B. Storage	7-2
SPECIFICATIONS	8-1
WIRING DIAGRAM	

DESCRIPTION

The engine serial number is stamped on the right side of the engine.



1. Engine serial number

NOTE:

The first three digits of the numbers are for model identification. The remaining digits are the unit production number. Keep a record of these numbers for reference when ordering parts from a Yamaha dealer.



DESCRIPTION

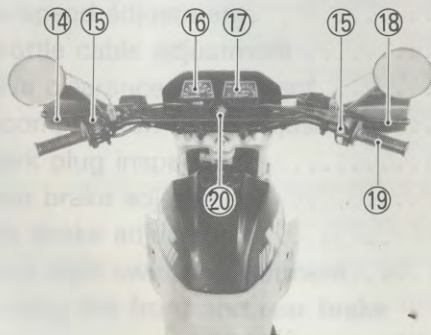
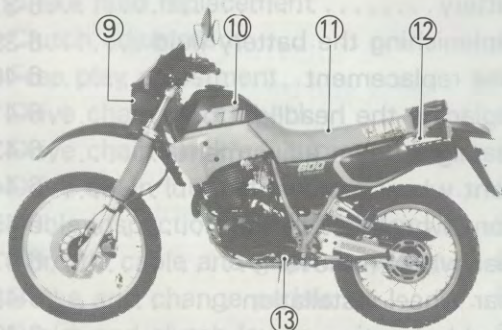
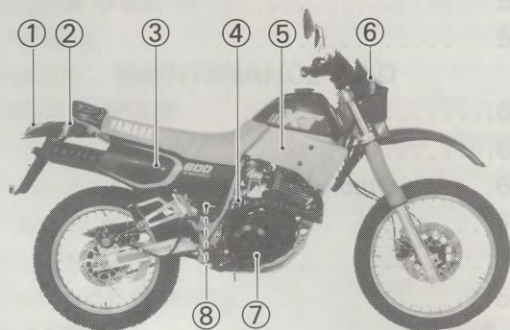

- | | |
|-------------------------|------------------------|
| 1. Tail/ Brake light | 11. Seat |
| 2. Rear flasher light | 12. Helmet holder |
| 3. Side cover | 13. Change pedal |
| 4. Kick starter | 14. Clutch lever |
| 5. Air duct | 15. Handlebar switches |
| 6. Front flasher light | 16. Speedometer |
| 7. Brake pedal | 17. Tachometer |
| 8. Monocross suspension | 18. Brake lever |
| 9. Headlight | 19. Throttle grip |
| 10. Fuel tank | 20. Main switch |

U-002

NOTE:

The motorcycle you have purchased may differ slightly from those shown in the photographs.

A-600

MOTORCYCLE IDENTIFICATION

A-602

Frame serial number

The frame serial number is stamped into the right side of the steering head pipe.

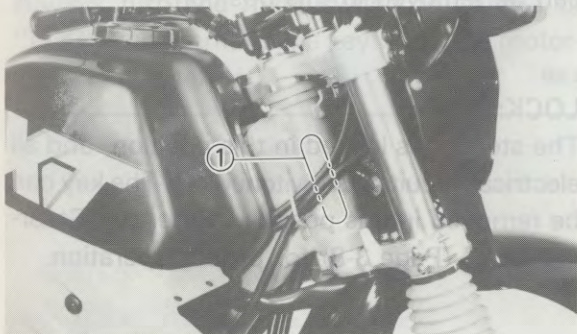

1. Frame serial number

A-701

Engine serial number

The engine serial number is stamped into the right side of the engine.

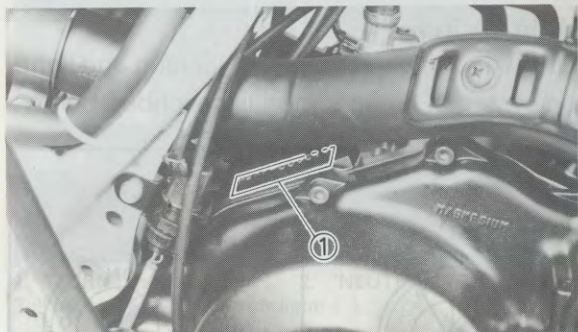

1. Engine serial number

U-003

NOTE:

The first three digits of these numbers are for model identification; the remaining digits are the unit production number. Keep a record of these numbers for reference when ordering parts from a Yamaha dealer.

CONTROL FUNCTIONS

B-001

Main switch

The main switch controls the ignition and lighting systems; its operation is described below.

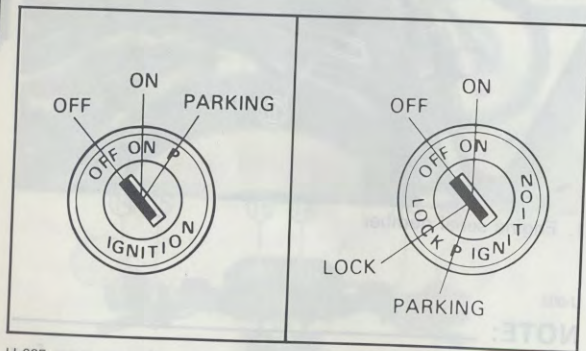

U-005

NOTE:

On this model the main switch comes in two types; one with a steering lock device and the other without it.

B-005

ON:

Electrical circuits are switched on. The engine can be started. The key cannot be removed in this position.

B-006

OFF:

All electrical circuits are switched off. The key can be removed in this position.

B-007

LOCK:

The steering is locked in this position, and all electrical circuits are switched off. The key can be removed in this position. Refer to "Steering lock" (Page 3-8) for proper operation.

NOTE:

B-010

PARKING:

The steering is locked in this position (only for the type with lock), and the taillight and auxiliary light come on but all other circuits are off. The key can be removed in this position.

U-007

NOTE:

Always turn the main switch to "OFF" or "LOCK" and remove the key when the motorcycle is unattended.

B-100

Indicator lights

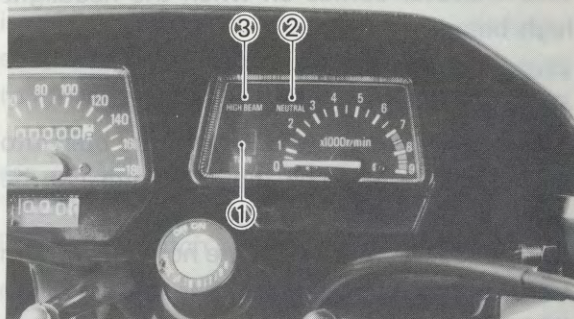

1. "TURN" indicator light
2. "NEUTRAL" indicator light
3. "HIGH BEAM" indicator light

B-101

"TURN" indicator light (orange):

This indicator flashes when the turn switch is "ON".

B-102

"NEUTRAL" indicator light (green):

This indicator comes on when the transmission is in neutral.

B-103

“HIGH BEAM” indicator light (blue):

This indicator comes on when the headlight high beam is used.

B-400

Speedometer

The odometer and trip odometer are built into the speedometer. The trip odometer can be reset to “0” with the reset switch.

Use the odometer to estimate how far you can ride on a tank of fuel before going to “RESERVE”. This information will enable you to plan fuel stops in the future.

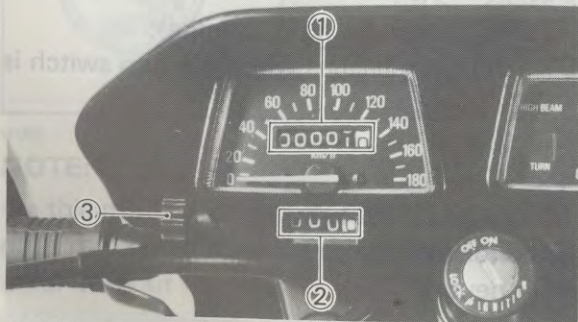

1. Odometer 2. Trip odometer 3. Reset knob

B-403

Tachometer

This model is equipped with a tachometer so the rider can monitor the engine speed and keep it within the ideal power range.

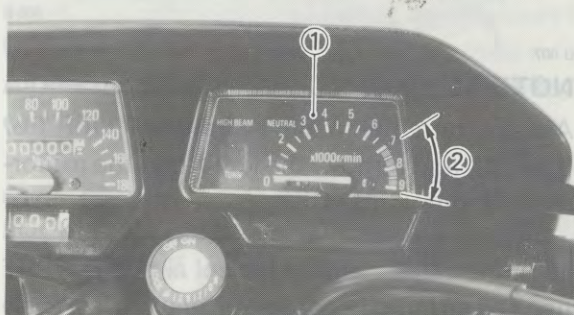

1. Tachometer 2. Red zone

U-304

CAUTION:

Do not operate in the red zone.
Red zone: 7,000 r/min and above

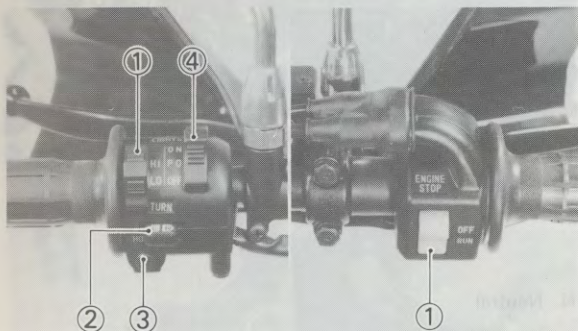
Handlebar switches:

1. "LIGHTS" (Dimmer) switch
2. "TURN" switch
3. "HORN" switch
4. "LIGHTS" switch

B-601

"LIGHTS" (Dimmer) switch

Turn the switch to "HI" for the high beam and to "LO" for the low beam.

B-605

"TURN" signal switch

This is a three-way switch: the center position is off; turn to the "L" to turn on the left flasher and to the "R" for the right flasher. Be sure to turn the switch off after completing a turn.

B-602

"HORN" switch

Press the switch to sound the horn.

B-612

"LIGHTS" switch

Turn the light switch to "ON" to turn on the headlight, taillight, and meter lights. Turn the light switch to "PO" to turn on the auxiliary light, taillight, and meter lights.

B-609

"ENGINE STOP" switch

The engine stop switch is a safety device for use in an emergency such as when the motorcycle overturns or when trouble occurs in the throttle system. The engine will not run when the engine stop switch is turned to "OFF." In case of emergency, turn the switch to "OFF."

B-701

Clutch lever

The clutch lever is located on the left handlebar; it disengages or engages the clutch. Pull the clutch lever to the handlebar to disengage the clutch, and release the lever to engage the clutch. The lever should be pulled rapidly and released slowly for smooth starts.

B-800

Change pedal

The gear ratios of the constant-mesh 5-speed transmission are ideally spaced. The gears can be shifted by using the change pedal on the left side of the engine.

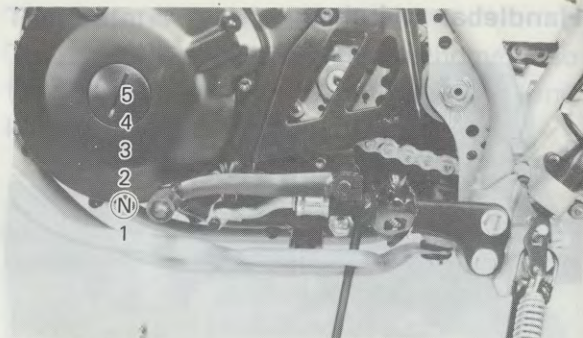

N. Neutral

B-900

Front brake lever

The front brake lever is located on the right handlebar. Pull it toward the handlebar to activate the front brake.

B-901

Rear brake pedal

The rear brake pedal is on the right side of the motorcycle. Press down on the brake pedal to activate the rear brake.

Fuel tank cap

1. To remove the tank cap, insert the key in the lock and turn the key 1/4 turn counterclockwise. Rotate the cap 1/3 turn counterclockwise and remove it from the tank.

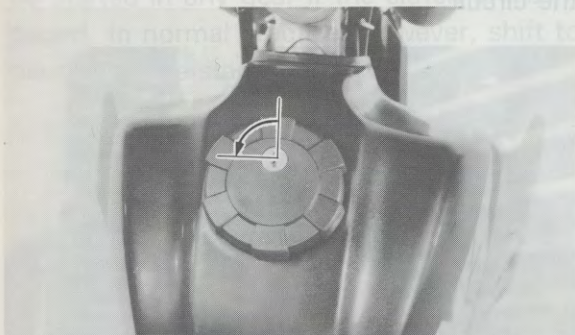

U-013

NOTE:

The tank cap cannot be reinstalled unless it is unlocked. The key must remain in the cap until the cap is properly installed and locked onto the fuel tank.

2. To reinstall the tank cap, set the cap in the filler neck and rotate the cap 1/3 turn clockwise. Lock the cap by turning the key 1/4 turn clockwise, and remove the key.

U-611

WARNING:

Be sure the cap is properly installed and locked in place before riding the motorcycle.

C-101

Fuel cock

The fuel cock supplies fuel from the tank to carburetor while filtering the fuel. The fuel cock has the three positions:

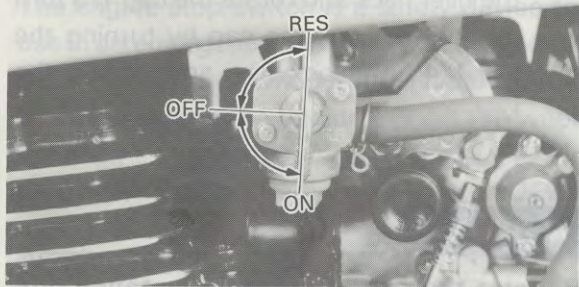

OFF: With the lever in this position, fuel will not flow. Always return the lever to this position when the engine is not running.

ON: With the lever in this position, fuel flows to the carburetor. Normal riding is done with the lever in this position.

RES: This indicates reserve. If you run out of fuel while riding, move the lever to this position. **FILL THE TANK AT THE FIRST OPPORTUNITY. BE SURE TO SET THE LEVER TO "ON" AFTER REFUELING.**

Starter knob (CHOKE)

When cold, the engine requires a richer air-fuel mixture for starting. A separate starter circuit supplies this mixture. Pull the starter knob out to open the circuit for starting. When the engine has warmed up, push the knob in to close the circuit.

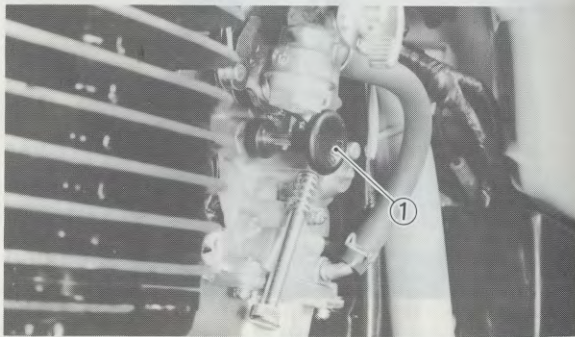

1. Starter knob

Kick starter

Rotate the kick starter away from the engine. Push the starter down lightly with your foot until the gears engage, then kick smoothly and forcefully to start the engine. This model has a primary-coupled kick starter so the engine can be started in any gear if the clutch is disengaged. In normal practice, however, shift to neutral before starting.

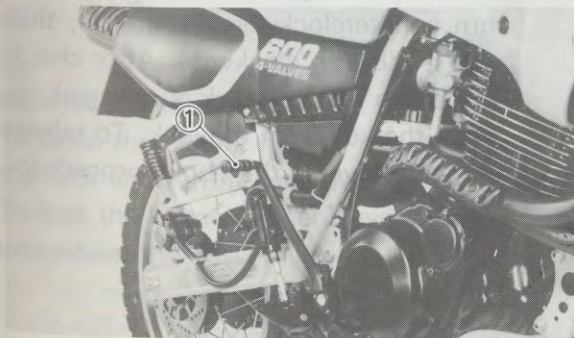

1. Kick starter

NOTE:

This model features an autodecomp. device, which frees the operator from the trouble otherwise required.

Steering lock

1. Combined with main switch

The steering is locked when the main switch is turned to "LOCK." To lock the steering, turn the handlebars all the way to the left or right. With the key at "OFF," push it into the main switch, turn the key counterclockwise to "LOCK," and remove the key. To release the lock, turn the key clockwise.

E

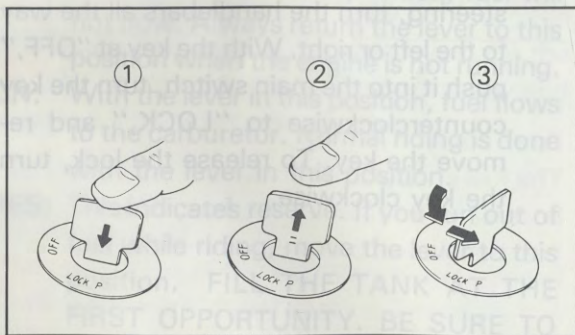
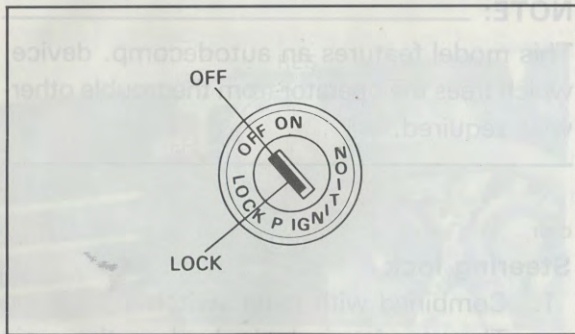

1. Push

2. Release

3. Turn

WARNING:

Never turn the key to "LOCK" when the motorcycle is moving.

2. Separate

To lock the steering, turn the handlebars all the way to the right, and insert the key into the steering lock. Turn the key 1/8 turn counterclockwise, push it in, then turn it 1/8 turn clockwise. After checking to see that the lock is engaged, remove the key from the lock. To release the lock, reverse the above procedure.

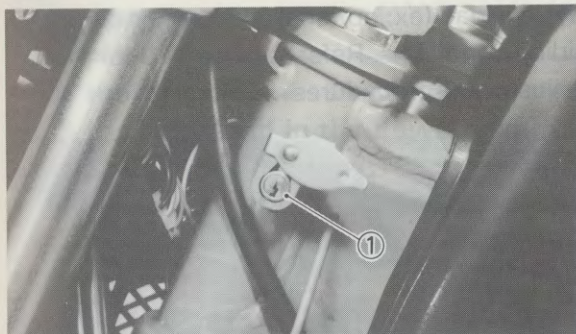

1. Steering lock

C-501

Helmet holder

To open the helmet holder, insert the key in the lock and turn it as shown.

To lock the helmet holder, reverse the above procedure.

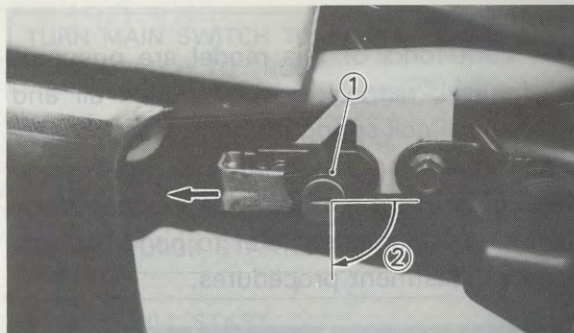

1. Helmet holder 2. Open

U-615

WARNING:

Never ride with a helmet in the helmet holder. It could interfere with rear wheel movement, causing loss of control and possibly an accident.

WARNING

Front forks

The front forks of this model are pneumo-mechanical; namely, a combination air and mechanical coil spring in the inner tubes. By adjusting the air pressure, you can alter the suspension to suit the motorcycle's load and the operating conditions. Refer to page 6-31 for proper adjustment procedures.

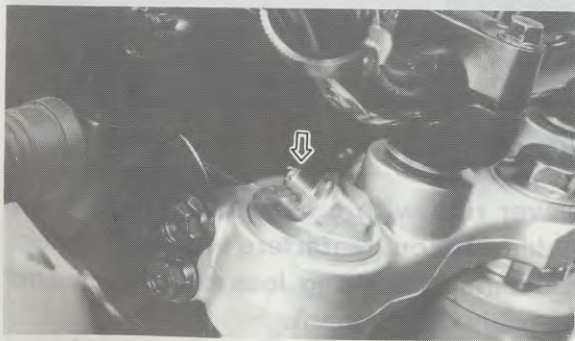

C-900

Rear shock absorber

The spring preload and the damping of the rear shock absorber can be adjusted to suit motor-

cycle's load (ex: optional accessories etc.) and riding conditions. Refer to page 6-33 for proper adjustment procedures.

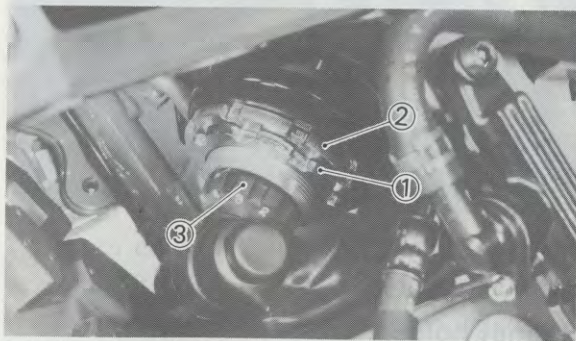

1. Lock nut 2. Adjuster 3. Damping adjuster

D-301

Sidestand

This model is equipped with an ignition circuit cut-off system. The motorcycle must not be ridden when the sidestand is down. The sidestand is located on the left side of the frame. (Refer to page 5-3 for an explanation of this system.)

WARNING:

This motorcycle must not be operated with the sidestand in the down position. If the stand is not properly retracted, it could contact the ground and distract the operator resulting in a possible loss of control. Yamaha has designed into this motorcycle a lockout system to assist the operator in fulfilling his responsibility of retracting the sidestand. Please check carefully the operating instructions listed below and if there is any indication of a malfunction, you must return the motorcycle to a Yamaha dealer immediately for repair.

D-305

Sidestand switch operation check

Check the operation of the sidestand switch against the information below.

TURN MAIN SWITCH TO "ON" AND ENGINE STOP SWITCH TO "RUN".



TRANSMISSION IS IN NEUTRAL AND SIDESTAND IS DOWN.



KICK THE KICK STARTER.



ENGINE WILL START.



PULL IN CLUTCH LEVER AND PUT TRANSMISSION IN GEAR.



ENGINE WILL STALL.



SIDESTAND SWITCH IS OK.

U-691

WARNING:

If improper operation is noted, consult a Yamaha dealer immediately.

PRE-OPERATION CHECKS

Before using this motorcycle, check the following points:

Item	Routine	Page
Front and rear brakes	Check operation, free play, fluid level, and fluid leakage. Top-up with DOT #3 (Front)/DOT #4 (Rear) brake fluid if necessary.	4-3 ~ 4-4, 6-17 ~ 6-22
Clutch	Check operation, condition and free play. Adjust if necessary.	4-4, 6-22 ~ 6-23
Throttle grip/Housing	Check for smooth operation. Lubricate/Adjust if necessary.	4-4, 6-13 ~ 6-15, 6-26
Engine oil	Check oil level/Add oil as required.	4-4 ~ 4-5, 6-6 ~ 6-9
Drive chain	Check chain slack and condition. Adjust if necessary.	4-5, 6-23 ~ 6-25
Wheels/Tires	Check tire pressure, wear, damage, spoke tightness.	4-5 ~ 4-8, 6-44 ~ 6-48
Control/Meter cables	Check for smooth operation. Lubricate if necessary.	6-25 ~ 6-26
Brake and change pedal shafts	Check for smooth operation. Lubricate if necessary.	6-26
Brake and clutch lever pivots	Check for smooth operation. Lubricate if necessary.	6-26
Sidestand pivot	Check for smooth operation. Lubricate if necessary.	6-26
Fittings/Fasteners	Check all chassis fittings and fasteners. Tighten/Adjust, if necessary.	4-8, 6-5

Item	Routine	Page
Fuel tank	Check fuel level/top-up as required.	4-9
Lights and signals	Check for proper operation.	4-8, 6-41 ~ 6-44
Battery	Check fluid level, top-up with distilled water if necessary.	4-8, 6-37 ~ 6-40

NOTE:

Pre-operation checks should be made each time the motorcycle is used. Such an inspection can be thoroughly accomplished in a very short time; and the added safety it assures is more than worth the time involved.

WARNING:

If any item in the Pre-Operation Check is not working properly, have it inspected and repaired before operating the motorcycle.



Brakes (See page 6-17 for more detail)

1. Brake lever and brake pedal

Check for correct free play in the front brake lever and rear brake pedal. Make sure they are working properly. Check the brakes at low speed shortly after starting out. If the free play is incorrect, adjust it.

U-619

WARNING:

A soft, spongy feeling in the brake lever (and/or brake pedal) indicates a failure in the brake system. Do not operate the motorcycle until the failure in the brake system is corrected. Ask a Yamaha dealer for immediate repairs. A soft, spongy feeling could indicate a hazardous condition in the brake system.

2. Brake fluid

Check the brake fluid level.
Add fluid if necessary.

Recommended brake fluid:

Front: DOT #3

Rear: DOT #4

3. Check the disc pads.

Refer to page 6-20.

U-022

NOTE:

When this brake service is necessary, ask a Yamaha dealer.

E-107

Brake fluid leakage

Apply each brake for a few minutes. Check to see if any brake fluid leaks out from the pipe joints or the master cylinder(s).

WARNING:

If brake fluid leakage is found, ask a Yamaha dealer for immediate repairs. Such leakage could indicate a hazardous condition.

E-200

Clutch (See page 6-22 for more detail)

Check the free play in the clutch lever, and make sure the lever operates properly. If the free play is incorrect, adjust it.

E-301

Throttle grip (See page 6-13 for more detail)

Turn the throttle grip to see if it operates properly, and check the free play. Make sure the grip returns by spring force when released. Ask a Yamaha dealer to make any necessary adjustments.

Engine oil (See page 6-6 for more detail)
Make sure the engine oil is at the specified level. Add oil as necessary.

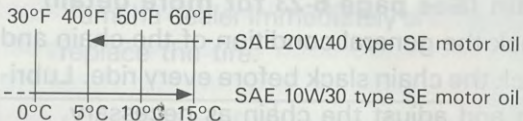
Recommended oil:**Oil quantity:****Total amount:**

2.4 L (2.1 Imp qt, 2.5 US qt)

Periodic oil change:

2.0 L (1.8 Imp qt, 2.1 US qt)

With oil filter replacement:

2.1 L (1.9 Imp qt, 2.2 US qt)

Oil tank capacity:

1.7 L (1.5 Imp qt, 1.8 US qt)

E

NOTE: _____

Recommended engine oil classification; API Service "SE", "SF" type or equivalent (e.g. "SF-SE", "SF-SE-CC", "SF-SE-SD" etc.).

E-500

Chain (See page 6-23 for more detail)

Check the general condition of the chain and check the chain slack before every ride. Lubricate and adjust the chain as necessary.

E-912

Tires

To ensure maximum performance, long service, and safe operation, note the following:

1. Tire air pressure
Always check and adjust the tire pressure before operating the motorcycle.

U-675

WARNING: _____

Tire inflation pressure should be checked and adjusted when the temperature of the tire equals the ambient air temperature.

Tire inflation pressure must be adjusted according to total weight of cargo, rider, passenger, and accessories (fairing, saddlebags, etc. if approved for this model), and vehicle speed.

Basic weight: With oil and full fuel tank	153 kg (337 lb)	
Maximum load*	202 kg (445 lb)	
Cold tire pressure	Front	Rear
Up to 90 kg (198 lb) load*	150 kPa (1.5 kg/cm ² , 21 psi)	150 kPa (1.5 kg/cm ² , 21 psi)
90 kg (198 lb) ~ Maximum load*	150 kPa (1.5 kg/cm ² , 21 psi)	180 kPa (1.8 kg/cm ² , 26 psi)
Off-road riding	100 kPa (1.0 kg/cm ² , 14 psi)	100 kPa (1.0 kg/cm ² , 14 psi)
High speed riding	150 kPa (1.5 kg/cm ² , 21 psi)	150 kPa (1.5 kg/cm ² , 21 psi)

*Load is the total weight of cargo, rider, passenger, and accessories.

WARNING:

Proper loading of your motorcycle is important for the handling, braking, and other performance and safety characteristics of your motorcycle. Do not carry loosely packed items that can shift. Securely pack your heaviest items close to the center of the motorcycle, and distribute the weight evenly from side to side. Properly adjust the suspension for your load, and check the condition and pressure of your tires. **NEVER OVERLOAD YOUR MOTORCYCLE.** Make sure the total weight of the cargo, rider, passenger, and accessories (fairing, saddlebags, etc. if approved for this model) does not exceed the maximum load of the motorcycle. Operation of an overloaded motorcycle could cause tire damage, an accident, or even injury.

2. Tire inspection

Always check the tires before operating the motorcycle. If a tire tread shows crosswise lines (minimum tread depth), if the tire has a nail or glass fragments in it, or if the side wall is cracked, contact a Yamaha dealer immediately and have him replace the tire.

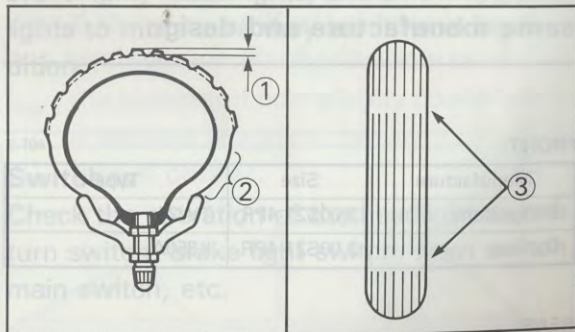

1. Tread depth 2. Side wall 3. Wear indicator

WARNING:

E After extensive tests, the tires mentioned below have been approved by Yamaha motor Co., Ltd. for this model. No guarantee for handling characteristics can be given if tire combinations other than what is approved are used on this motorcycle. The front and rear tires should be of the same manufacture and design.

FRONT:

Manufacture	Size	Type
Bridgestone	3.00S21-4PR	TW25
Dunlop	3.00S21-4PR	K850A

REAR:

Manufacture	Size	Type
Bridgestone	4.60S18-4PR	TW26
Dunlop	4.60S18-4PR	K850A

Minimum tire tread depth (front and rear)	1.0 mm (0.04 in)
---	------------------

U-700

WARNING:

1. It is dangerous to ride with a worn-out tire. When a tire tread begins to show lines, have a Yamaha dealer replace the tire immediately. Brakes, tires, and related wheel parts replacement should be left to a Yamaha Service Technician.
2. Patching a punctured tube is not recommended. If it is absolutely necessary to do so, use great care and replace the tube as soon as possible with a good quality replacement.

Wheels

To ensure maximum performance, long service, and safe operation, note the following:

1. Always inspect the wheels before a ride. Check for cracks, bends, or warpage of the wheel; be sure the spokes are tight and undamaged. If any abnormal condition exists in a wheel, consult a Yamaha dealer. Do not attempt even small repairs to the wheel. If a wheel is deformed or cracked, it must be replaced.
2. Tires and wheels should be balanced whenever either one is changed or replaced. Failure to have a wheel balanced can result in poor performance, adverse handling characteristics, and shortened tire life.
3. After installing a tire, ride conservatively to allow the tire to seat itself on the rim properly. Failure to allow proper seating may cause tire failure, resulting in damage to the motorcycle and injury to the rider.

Fittings/Fasteners

Always check the tightness of chassis fittings and fasteners before a ride. Use the chart on page 6-5 to find the correct torque.

Lights and signals

Check the headlight, flasher lights, taillight, brake light, meter lights, and all the indicator lights to make sure they are in working condition.

Switches

Check the operation of the headlight switch, turn switch, brake light switch, horn switch, main switch, etc.

Battery (See page 6-37 for more detail)

Check the fluid level and top-up if necessary. Use only distilled water if refilling is necessary.

Fuel

Make sure there is sufficient fuel in the tank.

U-610

WARNING:

Do not overfill the fuel tank. Avoid spilling fuel on the hot engine. Do not fill the fuel tank above the bottom of the filler tube as shown in the illustration or it may overflow when the fuel heats up later and expands.

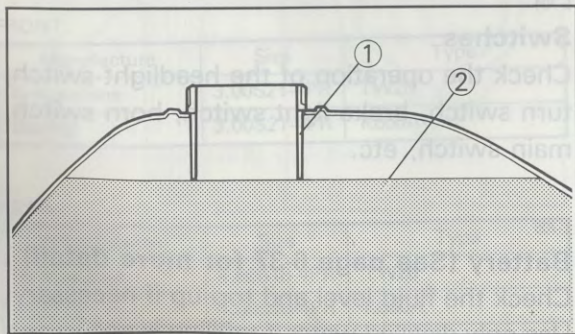

1. Filler tube

2. Fuel level

Recommended fuel: Regular gasoline

Fuel tank capacity:

Total:

13.0 L (2.9 Imp gal, 3.4 US gal)

Reserve:

2.0 L (0.4 Imp gal, 0.5 US gal)

OPERATION AND IMPORTANT RIDING POINTS

U-672

WARNING:

Before riding this motorcycle, become thoroughly familiar with all operating controls and their function. Consult a Yamaha dealer regarding any control or function that you do not thoroughly understand.

U-628

WARNING:

1. Never start your engine or let it run for any length of time in a closed area. The exhaust fumes are poisonous and can cause loss of consciousness and death within a short time. Always operate your motorcycle in an area with adequate ventilation.
2. Before starting out, always be sure the sidestand is up. Failure to retract the sidestand completely can result in a serious accident when you try to turn a corner.

E

Starting and warming up a cold engine

U-074

NOTE:

This motorcycle is equipped with an ignition circuit cut-off switch.

1. The engine can be started only under the following conditions:
 - a. The transmission is in neutral.
 - b. The sidestand is up, the transmission is in gear, and the clutch is disengaged.
2. The motorcycle must not be ridden when the sidestand is down.

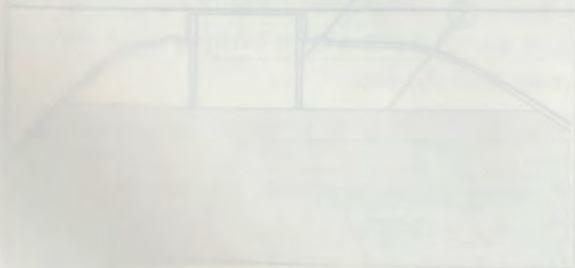

2. Fuel level

WARNING:

Before going through the following steps, check the function of the sidestand switch. (Refer to page 3-12.)

TURN MAIN SWITCH TO "ON" AND
ENGINE STOP SWITCH TO "RUN"

IF TRANSMISSION IS IN NEUTRAL
AND SIDESTAND IS DOWN

KICK THE KICK STARTER;
ENGINE WILL START

RETRACT SIDESTAND AND PUT
TRANSMISSION IN GEAR

MOTORCYCLE CAN BE RIDDEN

IF TRANSMISSION IS IN GEAR
AND SIDESTAND IS UP

PULL IN CLUTCH LEVER AND
KICK THE KICK STARTER;
ENGINE WILL START

MOTORCYCLE CAN BE RIDDEN

1. Turn the fuel cock to "ON."
2. Turn the ignition key to "ON" and the engine stop switch to "RUN."
3. Shift transmission into neutral

U-030

NOTE: _____

When the transmission is in neutral, the neutral indicator light (green) should be on. If the light does not come on, ask a Yamaha dealer to inspect it.

4. Fully open the starter (CHOKER), and completely close the throttle grip.
5. Kick the kick starter to start the engine.
6. After starting the engine, turn back the starter (CHOKER) to warming up position (about halfway).

U-026

NOTE: _____

To get maximum engine life, always warm up the engine before starting off. Never accelerate hard with a cold engine!

7. After warming up the engine, turn off the starter completely.

U-027

NOTE: _____

The engine is warm when it responds normally to the throttle with the starter turned off.

F-108

Starting a warm engine

The starter (CHOKER) is not required when the engine is warm.

CAUTION:

See "Break-in section" prior to operating the motorcycle for the first time.

Shifting

The transmission lets you control the amount of power you have available at a given speed for starting, accelerating, climbing hills, etc. The use of the change pedal is shown in the illustration. (Page 3-5)

To shift into NEUTRAL, depress the change pedal repeatedly until it reaches the end of its travel (you will feel a stop when you are in first gear) then raise the pedal slightly.

CAUTION:

1. Do not coast for long periods with the engine off, and do not tow the motorcycle a long distance. Even with gears in neutral, the transmission is only properly lubricated when the engine is running. Inadequate lubrication may damage the transmission.
2. Always use the clutch when changing gears. The engine, transmission, and driveline are not designed to withstand the shock of forced shifting and can be damaged by shifting without the clutch.

Engine break-in

There is never a more important period in the life of your motorcycle than the period between zero and 1,000 km (600 mi). For this reason we ask that you carefully read the following material. Because the engine is brand new, you must not put an excessive load on it for the first 1,000 km (600 mi). The various parts in the engine wear and polish themselves to the correct operating clearances. During this period, prolonged full throttle operation or any condition which might result in excessive heating of the engine, must be avoided.

F-316

1. 0 ~ 150 km (0 ~ 90 mi):

Avoid operation above 4,000 r/min. Stop the engine and let it cool for 5 to 10 minutes after every hour of operation. Vary the speed of the motorcycle from time to time. Do not operate it at one set throttle position.

2. 150 ~ 500 km (90 ~ 300 mi):

Avoid prolonged operation above 5,000 r/min. Rev the motorcycle freely through the gears, but do not use full throttle at any time.

3. 500 ~ 1,000 km (300 ~ 600 mi):

Avoid prolonged full throttle operation. Avoid cruising speeds in excess of 6,000 r/min.

U-372

CAUTION:

After 1,000 km (600 mi) of operation, be sure to replace the engine oil and oil filter element, and clean the oil strainer.

- ### 4. 1,000 km (600 mi) and beyond:
- Full throttle can be used.

CAUTION:

Never let engine speeds enter the red zone.

CAUTION:

If any engine trouble should occur during the break-in period, consult a Yamaha dealer immediately.

Parking

When parking the motorcycle, stop the engine and remove the ignition key. Turn the fuel cock to "OFF" whenever stopping the engine.

WARNING:

The muffler and exhaust pipe are hot. Park the motorcycle in a place where pedestrians or children are not likely to touch the motorcycle.

Do not park the motorcycle on a slope or soft ground; the motorcycle may overturn.

E

PERIODIC MAINTENANCE AND MINOR REPAIR

E

H-004

Periodic inspection, adjustment, and lubrication will keep your motorcycle in the safest and most efficient condition possible. Safety is an obligation of the motorcycle owner. The maintenance and lubrication schedule chart should be considered strictly as a guide to general maintenance and lubrication intervals. **YOU MUST TAKE INTO CONSIDERATION THAT WEATHER, TERRAIN, GEOGRAPHICAL LOCATIONS, AND A VARIETY OF INDIVIDUAL USES ALL TEND TO DEMAND THAT EACH OWNER ALTER THIS TIME SCHEDULE TO SHORTER INTERVALS TO MATCH HIS ENVIRONMENT.** The most important points of motorcycle inspection, adjust-

ment, and lubrication are explained in the following pages.

H-632

WARNING:

If you are not familiar with motorcycle service, this work should be done by a Yamaha dealer.

H-101

Tool kit

The service information included in this manual is intended to provide you, the owner, with the necessary information for completing some of your own preventive maintenance and minor repairs. The tools provided in the owner's tool kit are sufficient for most of these purposes; however a torque wrench is also necessary to properly tighten nuts and bolts.

WARNING:

Modifications to this motorcycle not approved by Yamaha may cause loss of performance, and render it unsafe for use. Consult a Yamaha dealer before attempting any changes.



1. Tool kit

U-060

NOTE:

If you do not have a torque wrench available during a service operation requiring one, take your motorcycle to a Yamaha dealer to check the torque settings and adjust them as necessary.

PERIODIC MAINTENANCE/LUBRICATION

Unit: km (mi)

ITEM	REMARKS	BREAK-IN 1,000 (600)	EVERY	
			6,000 (4,000) or 6 months	12,000 (8,000) or 12 months
Valve clearance*	Check/Adjust valve clearance.	<input type="radio"/>	<input type="radio"/>	<input type="radio"/>
Spark plug	Check/Clean/Replace if necessary.	<input type="radio"/>	<input type="radio"/>	<input type="radio"/>
Air filter	Clean. Replace if necessary.	<input type="radio"/>	<input type="radio"/>	<input type="radio"/>
Carburetor*	Check/Adjust/idle speed, starter operation.	<input type="radio"/>	<input type="radio"/>	<input type="radio"/>
Fuel line*	Check fuel hose for cracks or damage.	<input type="radio"/>	<input type="radio"/>	<input type="radio"/>
Engine oil	Replace (Warm engine before draining).	<input type="radio"/>	<input type="radio"/>	<input type="radio"/>
Engine oil filter/ Oil strainer	Replace filter element and clean oil strainer.	<input type="radio"/>	<input type="radio"/>	<input type="radio"/>
Brake*	Check operation/fluid leakage/See NOTE./ Adjust if necessary.	<input type="radio"/>	<input type="radio"/>	<input type="radio"/>
Clutch*	Check operation/Adjust if necessary.	<input type="radio"/>	<input type="radio"/>	<input type="radio"/>
Decompression system	Check/Adjust if necessary.	<input type="radio"/>	<input type="radio"/>	<input type="radio"/>
Rear arm pivot*/ Relay arm*	Check rear arm assembly for looseness. Clean and lube.***	CHECK	<input type="radio"/>	<input type="radio"/>
Wheels*	Check balance/damage/runout/spoke tightness.	<input type="radio"/>	<input type="radio"/>	<input type="radio"/>
Wheel bearings*	Check bearings assembly for looseness/damage. Replace if damaged.	<input type="radio"/>	<input type="radio"/>	<input type="radio"/>
Steering bearing*	Check bearings assembly for looseness. Moderately repack every 24,000 (16,000) or 24 months.**	CHECK	<input type="radio"/>	CHECK
Front forks*	Check operation/oil leakage.	<input type="radio"/>	<input type="radio"/>	<input type="radio"/>

Unit: km (mi)

ITEM	REMARKS	BREAK-IN 1,000 (600)	EVERY	
			6,000 (4,000) or 6 months	12,000 (8,000) or 12 months
Rear shock absorber*	Check operation/oil leakage.		○	○
Drive chain	Check and adjust slack/alignment/clean/lube.		EVERY 500 (300)	
Fittings/Fasteners*	Check all chassis fittings and fasteners.	○	○	○
Sidestand switch*	Check operation. Clean or replace if necessary.	○	○	○
Battery*	Check specific gravity. Check breather pipe for proper operation.		○	○

*: It is recommended that these items be serviced by a Yamaha dealer.

** : Medium weight wheel bearing grease.

*** : Lithium base grease.

NOTE:

Brake fluid replacement:

1. When disassembling the master cylinder or caliper cylinder, replace the brake fluid. Normally check the brake fluid level and add the fluid as required.
2. On the inner parts of the master cylinder and caliper cylinder, replace the oil seals every two years.
3. Replace the brake hose every four years, or if cracked or damaged.

Torque specifications

Use a torque wrench to tighten these items. It is recommended that these items be checked occasionally, especially before a long trip. Always check the tightness of these items whenever they are loosened for any reason.

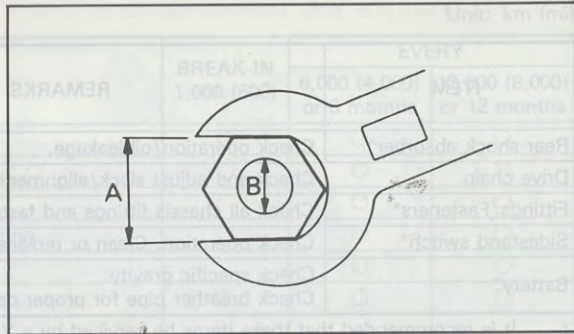

A (Nut)	B (Bolt)	General torque specifications		
		Nm	m•kg	ft•lb
10 mm	6 mm	6	0.6	4.3
12 mm	8 mm	15	1.5	11
14 mm	10 mm	30	3.0	22
17 mm	12 mm	55	5.5	40
19 mm	14 mm	85	8.5	61
22 mm	16 mm	130	13.0	94

Item	Torque		
	Nm	m•kg	ft•lb
Spark plug	18	1.8	13
Engine drain bolt (Crankcase)	30	3.0	22
Engine drain bolt (Oil tank)	18	1.8	13
Oil filter cover screw	10	1.0	7
Air bleed screw	5	0.5	4
Front fork pinch bolt	23	2.3	17
Front fork cap bolt	23	2.3	17
Handlebar installation bolt	20	2.0	15
Front wheel axle nut	110	11.0	80
Axle holder nut	8	0.8	6
Rear wheel axle nut	90	9.0	65
Caliper bracket bolt	45	4.5	33

Engine oil

In this model, the dry sump lubrication system is used. That is, oil is supplied to the engine by means of the feed pump, after lubricating is over, the oil is fed back to the oil tank by means of the scavenging pump. Therefore, the oil level can be checked at the oil tank.

1. Oil level measurement

- Place the motorcycle on a level place and hold it in an upright position.
- Remove the oil tank cap, and check the oil level.

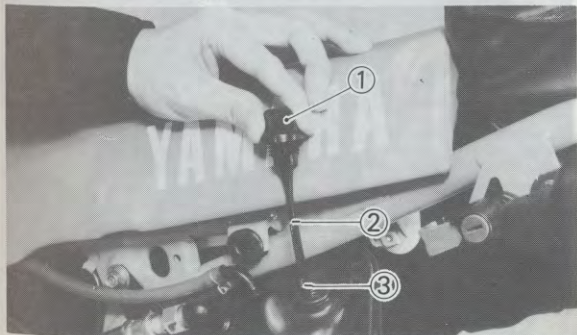

- Oil tank cap
- Maximum oil level
- Minimum oil level

NOTE:

When checking, do not screw the oil level gauge into the oil tank. Insert the gauge lightly. For accuracy, check with the motorcycle held upright.

- If the oil level is between the minimum and maximum level lines marked on the oil level gauge, you may start the engine. If there is no oil on the oil level gauge, add oil up to the minimum level.
- Start the engine and warm up until the oil temperature rises to approximately 60°C (140°F).
- Idle the engine more than 10 seconds while keeping the motorcycle upright. Then stop the engine and check the oil level on the upright motorcycle.
- Adjust the oil level to the maximum level line.

CAUTION:

Do not run the motorcycle until you know the motorcycle has enough engine oil.

E

U-715

WARNING:

Never attempt to remove the oil tank cap just after high speed operation. The heated oil could spout out, causing danger. Wait until the oil cools down to approximately 60°C (140°F).

2. Engine oil replacement
 - a. Start the engine and stop after a few minutes of warm-up.
 - b. Place an oil receiver under the engine.
 - c. Remove the oil tank cap, drain bolts (at two places), and air bleed screw attached to the oil filter cover.

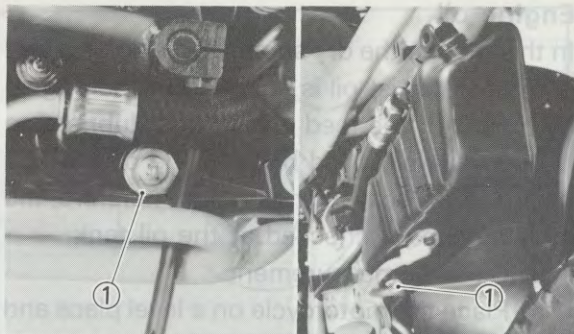

1. Drain bolt

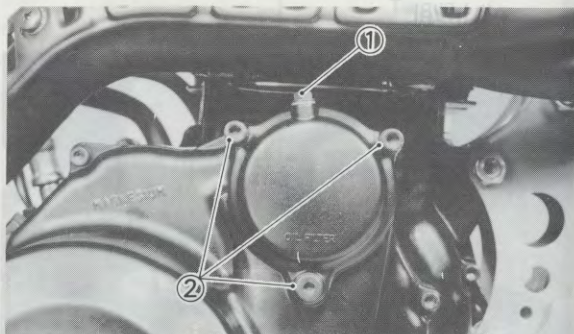

1. Air bleed screw

2. Filter cover screw

NOTE: _____

The oil filter cover is secured by three screws. The lower one should be removed so that the filter cavity will drain.

- d. Check each gasket. If damaged, replace.
- e. Remove the other filter cover screws and remove the oil filter cover. Replace the filter element.
- f. Check O-ring for damage. Replace if damaged.

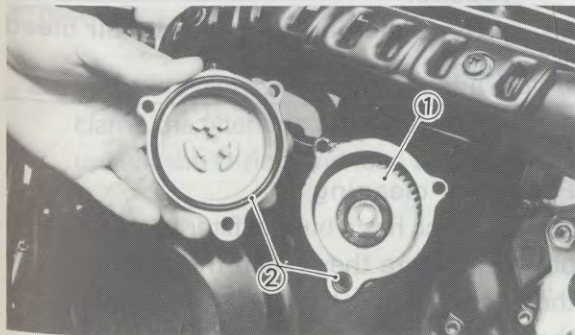

1. Filter element

2. O-ring

- g. Remove the oil hose and oil strainer.

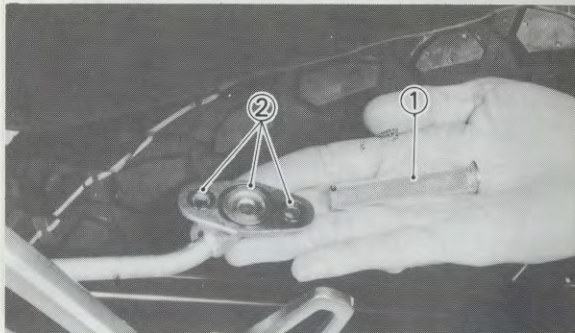

1. Oil strainer

2. O-ring

- h. Clean the oil strainer with solvent.
- i. Check the oil strainer and O-rings for damage.
- j. Install the drain bolts (at two places), the air bleed screw, and the filter cover screw.

Tightening torque:

Drain bolt (crankcase):

30 Nm (3.0 m•kg, 22 ft•lb)

Drain bolt (oil tank):

18 Nm (1.8 m•kg, 13 ft•lb)

Filter cover screw:

10 Nm (1.0 m•kg, 7 ft•lb)

Air bleed screw:

5 Nm (0.5 m•kg, 4 ft•lb)

- k. Add engine oil. Install the oil tank filler cap and tighten.

Oil capacity: See page 4-4

Recommended oil: See page 4-4

- l. Start the engine and allow a few minutes of warm-up. While warming up, check for oil leakage. If oil leaks, stop the engine immediately, and check for the cause.
- m. Stop the engine and check the oil level.

CAUTION:

After replacing the engine oil, be sure to check the oil pressure as described below.

1. Remove the air bleed screw from oil filter cover.
2. Start the engine and keep it idling until oil flows out of the bleed hole. If no oil comes out after a lapse of one minute, turn off the engine immediately so it will not seize. In such a case go to the nearest Yamaha dealer for repairs.
3. After checking, tighten the air bleed screw securely.

H-600

Fuel cock cleaning

The fuel cock has a built-in filter to remove any particles before they reach the carburetor. If the filter becomes blocked, fuel cannot enter the carburetor.

1. First, turn the cock lever to the "OFF" then remove the filter cup and clean the bottom of the cup with solvent.

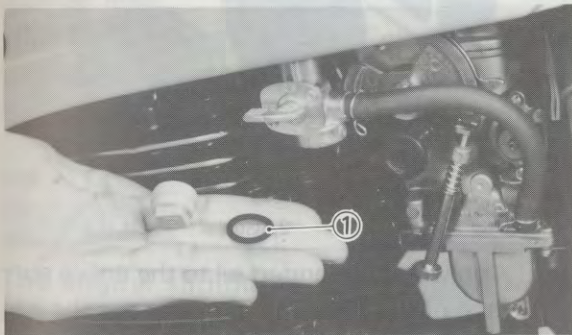

1. O-ring

2. When reassembling, be careful not to clamp the filter cup too tightly as this may unseat the O-ring and lead to a fuel leak.

Air filter

1. Remove the side cover.



2. Remove the air filter case fitting screws and the filter case cover.

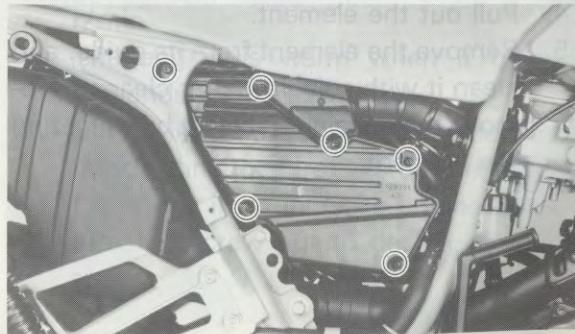

E

E

3. Pull out the element set plate.

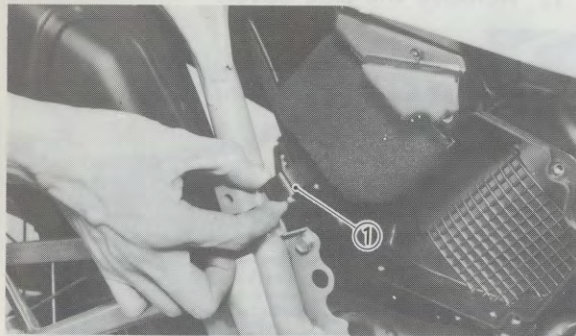

1. Element set plate

4. Pull out the element.
5. Remove the element from its guide, and clean it with solvent. After cleaning, remove the remaining solvent by squeezing the element.

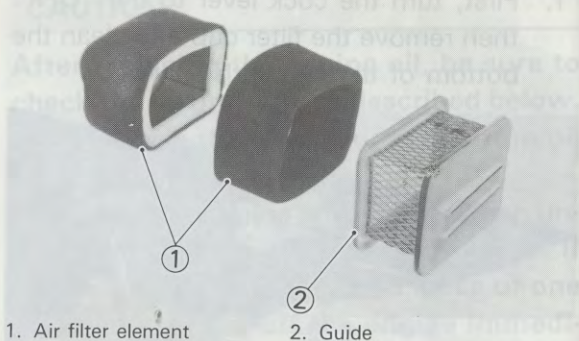

1. Air filter element

2. Guide

6. Apply recommended oil to the entire surface of the filter and squeeze out the excess oil. The element should be wet but not dripping.

Recommended oil:
Foam-air-filter oil or SAE 10W30
motor oil

7. When installing the element in its case, be sure its sealing surface matches the sealing surface of the case so there is no air leak.
8. The element should be cleaned at the specified intervals. It should be cleaned more often if the motorcycle is operated in dusty or wet areas.

U-326

CAUTION:

The engine should never be run without the air cleaner element; excessive piston and/or cylinder wear may result.

H-900

Carburetor adjustment

The carburetor is a vital part of the engine and requires very sophisticated adjustment. Most adjustments should be left to a Yamaha dealer who has the professional knowledge and experience to do so. However, the following point may be serviced by the owner as part of this routine maintenance.

U-330

CAUTION:

The carburetor was set at the Yamaha factory after many tests. If the settings are disturbed, poor engine performance and damage may result.

H-901

Idle speed adjustment

1. Start the engine and warm it up for a few minutes (normally, 1 or 2 minutes) at approximately 1,000 to 2,000 r/min. Occasionally rev the engine to 4,000 to 5,000 r/min.

The engine is warm when it quickly responds to the throttle.

2. Set the idle to the specified engine speed by adjusting the throttle stop screw; turn the screw in to increase engine speed, turn the screw out to decrease engine speed.

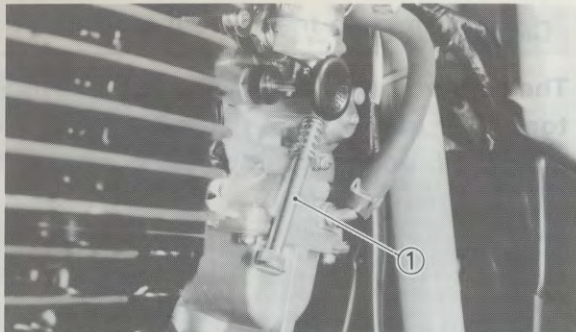

1. Throttle stop screw

Standard idle speed:
1,250 ~ 1,350 r/min

U-045

NOTE:

If the specified idle speed cannot be obtained by performing the above adjustment, consult a Yamaha dealer.

H-906

Throttle cable adjustment

U-064

NOTE:

Before adjusting the throttle cable free play, the engine idling speed should be adjusted.

The throttle cable should have a specified free play in the turning direction at the grip flange. If the play is incorrect, take the following steps for adjustment.

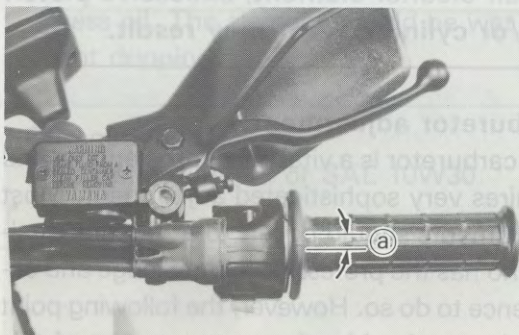

a. 2 ~ 5 mm (0.08 ~ 0.20 in)

Free play:

2~5 mm (0.08~0.20 in)

1. Remove the seat.

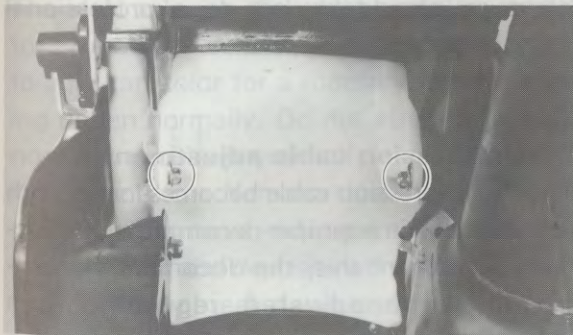

Standard spark plug:

DR7ES or DPR7EA-9 or
DPR8EA-9 (NGK)

2. Remove the air ducts.



3. Turn the fuel cock to "OFF" and remove the fuel pipe.

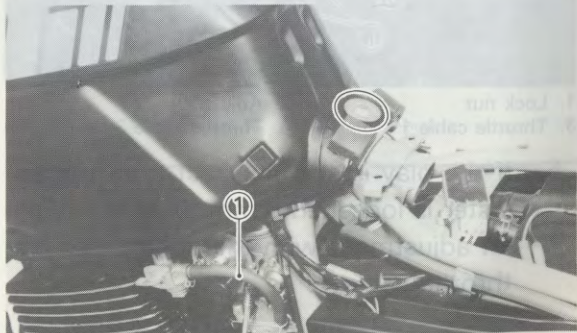

4. Remove the fuel tank.
5. Loosen the lock nuts on the carburetor side of throttle cable 1, and turn the adjuster in and out so the play is correct. After the adjustment, be sure to tighten the lock nut.

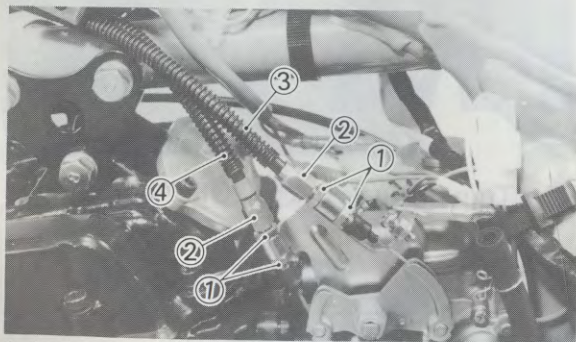

- | | |
|---------------------|---------------------|
| 1. Lock nut | 2. Adjuster |
| 3. Throttle cable 1 | 4. Throttle cable 2 |

6. If the play is still incorrect after the adjuster is loosened 5 mm (0.20 in), make an adjustment with the adjuster on the throttle cable 2.

H-908

Valve clearance adjustment

The valve clearance becomes larger with use, resulting in improper fuel/air supply and engine noise. To prevent this, the valve clearance must be adjusted regularly. This adjustment, however, should be left to a professional Yamaha service technician.

H-907

Decompression cable adjustment

The decompression cable becomes longer with use, resulting in improper decompression function. To prevent this, the decompression cable must be adjusted regularly. This adjustment, however, should be left to a Yamaha dealer.

Spark plug inspection

The spark plug is an important engine component and is easy to inspect. The condition of the spark plug can indicate something of the condition of the engine.

The ideal color on the white porcelain insulator around the center electrode is a medium to light tan color for a motorcycle that is being ridden normally. Do not attempt to diagnose any problems yourself. Instead, take the motorcycle to a Yamaha dealer. You should periodically remove and inspect the spark plug because heat and deposits will cause the spark plug to slowly break down and erode. If electrode erosion becomes excessive, or if carbon and other deposits are excessive, you should replace the spark plug with a proper type plug.

Standard spark plug:

DR7ES or DPR7EA-9 or
DPR8EA-9 (NGK)

Before installing the spark plug, measure the electrode gap with a wire thickness gauge; adjust the gap to specification as necessary.

Spark plug gap:	
DR7ES	DPR7EA-9 or DPR8EA-9
0.6 ~ 0.7 mm (0.024 ~ 0.028 in)	0.8 ~ 0.9 mm (0.031 ~ 0.035 in)

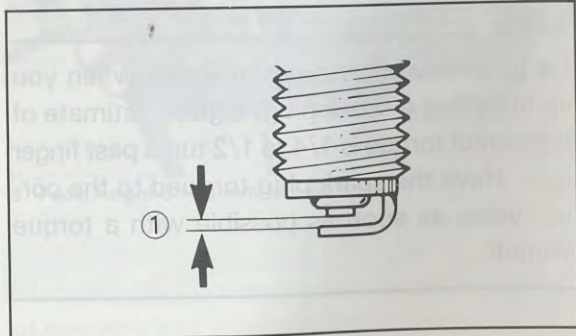

1. Spark plug gap

When installing the plug, always clean the gasket surface and use a new gasket. Wipe off any grime from the threads, and torque the spark plug properly.

E

Spark plug torque:
18 Nm (1.8 m•kg, 13 ft•lb)

U-038

NOTE: _____

If a torque wrench is not available when you are installing a spark plug, a good estimate of the correct torque is 1/4 to 1/2 turns past finger tight. Have the spark plug torqued to the correct value as soon as possible with a torque wrench.

H-801

Front brake adjustment

The free play at the end of the front brake lever should be 2~5 mm (0.08~0.20 in).

1. Loosen the lock nut.



1. Lock nut
 2. Adjuster
- a. 2~5 mm (0.08~0.20 in)

2. Turn the adjuster so that the brake lever movement at the lever end is 2~5 mm (0.08~0.20 in) before the adjuster contacts the master cylinder piston.
3. After adjusting, tighten the lock nut.

WARNING:

Check the brake lever free play. Be sure the brake is working properly.

WARNING:

A soft or spongy feeling in the brake lever can indicate the presence of air in the brake system. This air must be removed by bleeding the brake system before the motorcycle is operated. Air in the system will cause greatly diminished braking capability and can result in loss of control and an accident. Have a Yamaha dealer inspect and bleed the system if necessary.

Rear brake adjustment

The brake pedal top end should be 5 ~ 10 mm (0.2 ~ 0.4 in) below the top of the footrest. If not, ask a Yamaha dealer.

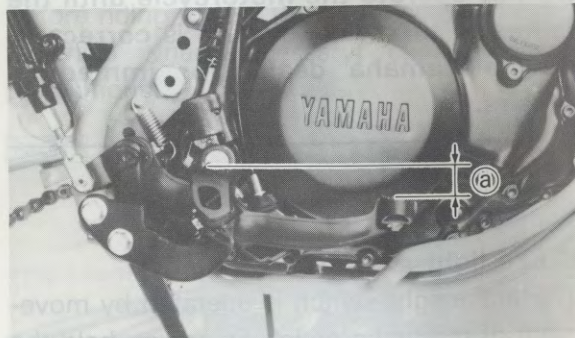

a. Pedal height 5 ~ 10 mm (0.2 ~ 0.4 in)

E

WARNING:

E An incorrect free play indicates a hazardous condition in the brake system. Do not operate the motorcycle until the failure in the brake system is corrected. Ask a Yamaha dealer for immediate repairs.

H-833

Brake light switch adjustment

The brake light switch is operated by movement of the brake pedal. To adjust, hold the main body of the switch with your hand so it does not rotate and turn the adjusting nut. Proper adjustment is achieved when the brake light comes on just before the brake begins to take effect.

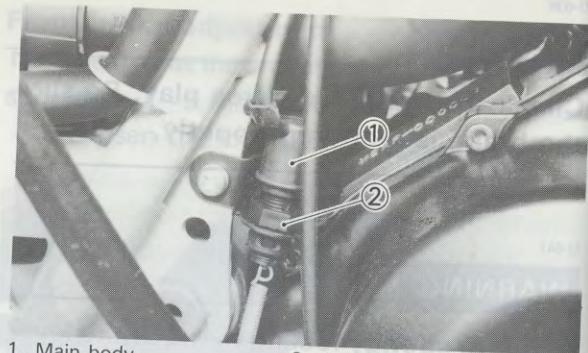

1. Main body

2. Adjuster

H-865K

Checking the front and rear brake pads

Check the brake pads for damage and wear. If the thickness is less than the specified value, have a Yamaha dealer replace the pads.

3. After adjusting, tighten the lock nut.

FRONT

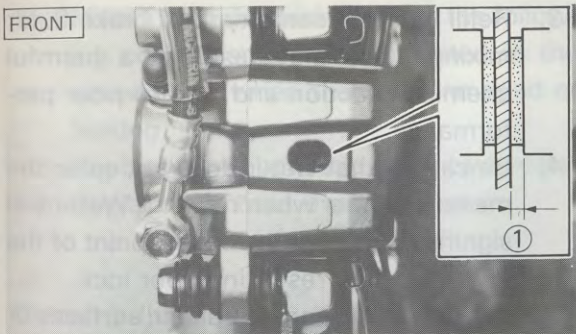

1. Wear limit 0.8 mm (0.031 in)

REAR

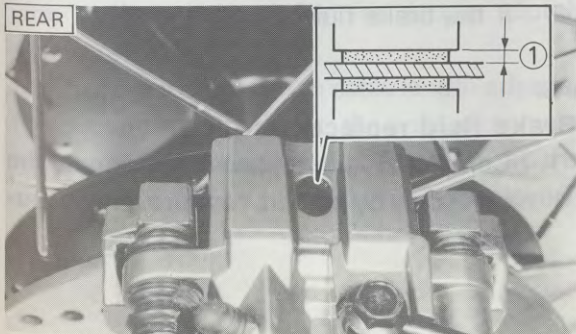

1. Wear limit 0.8 mm (0.031 in)

Inspecting the brake fluid level

Insufficient brake fluid may let air enter the brake system, possibly causing the brakes to become ineffective.

Before riding, check the brake fluid level and replenish when necessary; observe these precautions:

FRONT

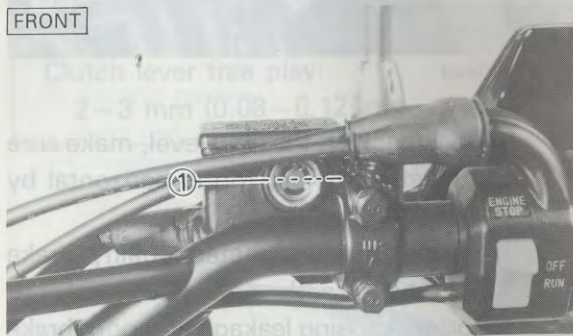

1. Lower level

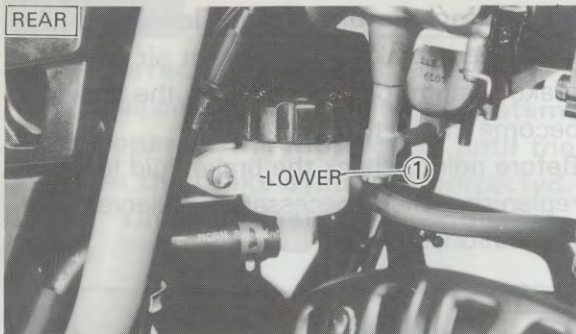

1. Lower level

1. When checking the fluid level, make sure the master cylinder top is horizontal by turning the handlebars.
2. Use only the designated quality brake fluid: otherwise, the rubber seals may deteriorate, causing leakage and poor brake performance.

Recommended brake fluids:

Front: DOT #3

Rear: DOT #4

3. Refill with the same type of brake fluid; mixing fluids may result in a harmful chemical reaction and lead to poor performance.
4. Be careful that water does not enter the master cylinder when refilling. Water will significantly lower the boiling point of the fluid and may result in vapor lock.
5. Brake fluid may erode painted surfaces or plastic parts. Always clean up spilled fluid immediately.
6. Have a Yamaha dealer check the cause if the brake fluid level goes down.

H-835

Brake fluid replacement

1. Complete fluid replacement should be done only by trained Yamaha service personnel.

2. Have a Yamaha dealer replace the following components when indicated in the schedule or when they are damaged or leaking.
 - a. Replace all rubber seals every two years.
 - b. Replace all hoses every four years.

I-001

Clutch adjustment

This model has two clutch cable length adjusters. The cable length adjusters are used to take up slack from cable stretch and to provide sufficient free play for proper clutch operation.

Normally, once the clutch cable length adjuster (crankcase) is properly set; the only adjustment required is maintenance of free play at the clutch cable length adjuster (handlebar lever).

I-005

Free play adjustment

The clutch should be adjusted to suit the rider's preference; but, free play at the lever pivot should be 2~3 mm (0.08~0.12 in).

Loosen either the handlebar lever adjuster lock nut or the cable length adjuster lock nut. Turn the cable length adjuster either in or out until proper lever free play is achieved.

Clutch lever free play:
2~3 mm (0.08~0.12 in)

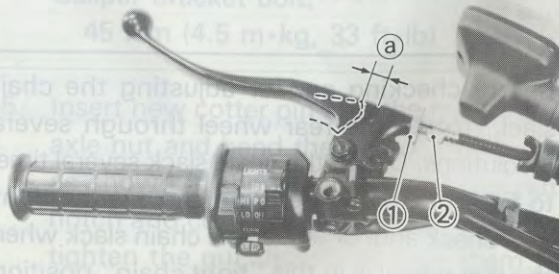

1. Lock nut 2. Adjuster a. 2~3 mm (0.08~0.12 in)

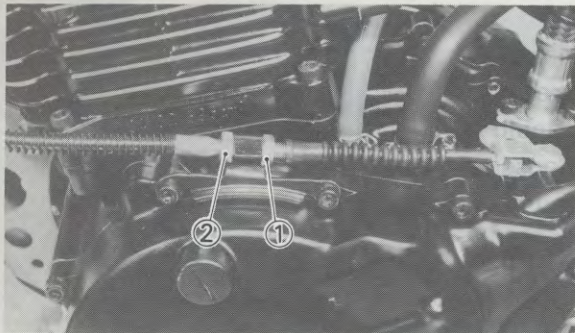

1. Lock nut

2. Adjuster

I-408

Drive chain slack check

U-048

NOTE:

Before checking and/or adjusting the chain slack, rotate the rear wheel through several revolutions. Check the chain slack several times to find the point where the chain is the tightest. Check and/or adjust the chain slack where the rear wheel is in this "tight chain" position.

To check the chain slack the motorcycle must stand vertically with its both wheels on the ground and without a rider. Check the slack at the position shown in the illustration. The normal vertical deflection is approximately 30 ~ 40 mm (1.2 ~ 1.6 in). If the deflection exceeds 40 mm (1.6 in) adjust the chain slack.

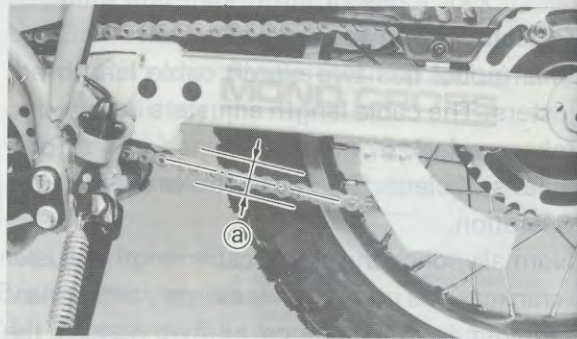

a. 30 ~ 40 mm (1.2 ~ 1.6 in)

Drive chain slack adjustment

1. Remove the cotter pin from the rear wheel axle nut.

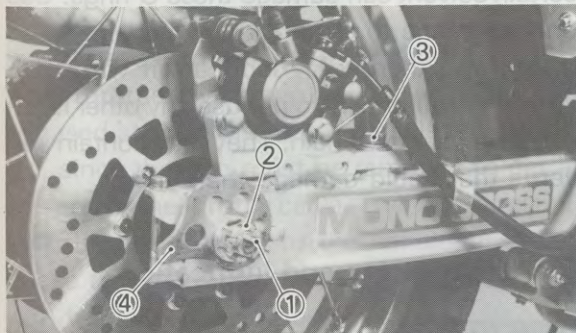

1. Cotter pin 2. Axle nut
3. Caliper bracket installation bolt 4. Chain puller

2. Loosen the rear wheel axle nut and caliper bracket installation bolt.
3. Turn chain puler both left and right, until axle is situated in same puller slot position.

CAUTION:

Too small chain slack will overload the engine and other vital parts; keep the slack within the specified limits.

4. After adjusting, be sure to tighten the axle nut and caliper bracket installation bolt.

Tightning torque:

Axle nut:

90 Nm (9.0 m•kg, 65 ft•lb)

Caliper bracket bolt:

45 Nm (4.5 m•kg, 33 ft•lb)

5. Insert new cotter pin into the rear wheel axle nut and bend the end of cotter pin as shown in the illustration. (If the nut notch and cotter pin hole do not match, tighten the nut slightly to align them.)

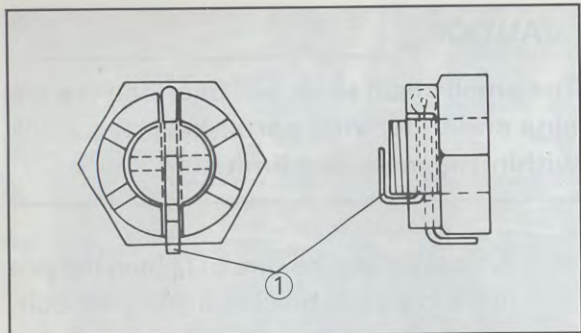
E

1. Cotter pin

U-647

WARNING:

Always use a new cotter pin on the axle nut.

I-407

Drive chain lubrication

The chain consists of many parts which work against each other. If the chain is not maintained properly, it will wear out rapidly, therefore, form the habit of periodically servicing the chain. This service is especially necessary when riding in dusty conditions.

This motorcycle has a drive chain with small rubber O-rings between the chain plates. Steam cleaning, high-pressure washes, and certain solvent can damage these O-rings. Use only kerosene to clean the drive chain. Wipe it dry, and thoroughly lubricate it with SAE 30 ~ 50W motor oil. Do not use any other lubricants on the drive chain. They may contain solvents that could damage the O-rings.

I-107

Cable inspection and lubrication

U-646

WARNING:

Damage to the outer housing of the various cables may cause corrosion and interfere with the movement of the cable. An unsafe condition may result so replace such cables as soon as possible.

Lubricate the inner cable and the cable end. If they do not operate smoothly, ask a Yamaha dealer to replace them.

Recommended lubricant:
SAE 10W30 motor oil

I-102

Throttle cable and grip lubrication

The throttle twist grip assembly should be greased at the time that the cable is lubricated, since the grip must be removed to get at the end of the throttle cable. Two screws clamp the throttle housing to the handlebar. Once these two are removed, the end of the cable can be held high to pour in several drops of lubricant. With the throttle grip disassembled, coat the metal surface of the grip assembly with a suitable all-purpose grease.

I-306

Brake and change pedals

Lubricate the pivoting parts.

Recommended lubricant:
SAE 10W30 motor oil

I-307

Brake and clutch levers

Lubricate the pivoting parts.

Recommended lubricant:
SAE 10W30 motor oil

I-311

Sidestand

Lubricate the pivoting parts. Check to see that the sidestand moves up and down smoothly.

Recommended lubricant:
SAE 10W30 motor oil

U-704

WARNING:

If the sidestand movement is not smooth,
consult a Yamaha dealer.

Rear suspension

Lubricate the pivoting parts.

Recommended lubricant:
Lithium soap base grease

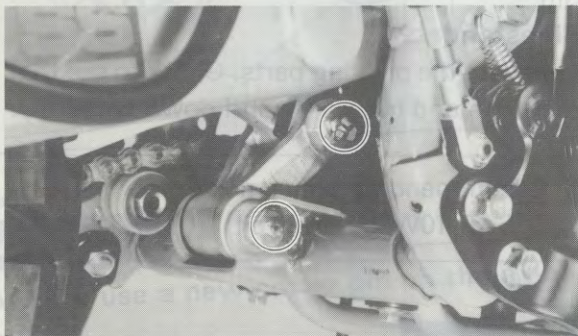
**Front fork oil change****WARNING:**

1. Fork oil leakage can cause loss of stability and safe handling. Have any problem corrected before operating the motorcycle.
2. Securely support the motorcycle so there is no danger of it falling over.

1. Elevate the front wheel by placing a suitable stand under the engine. Remove the handlebars.

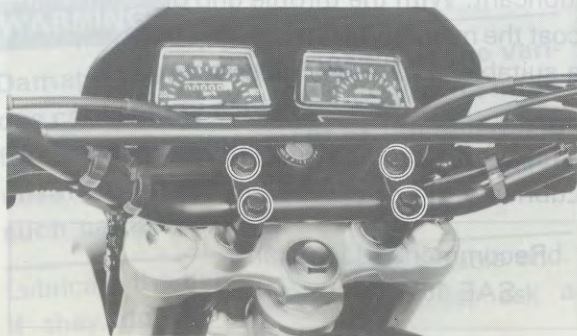

2. Remove the air valve cap from each fork.
3. Keep the valve open by pressing it for several seconds so that the air can be let out of the inner tube.

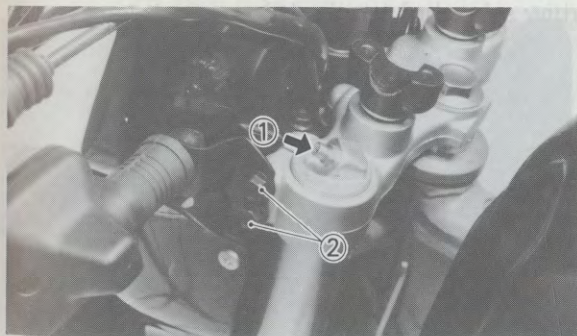

1. Push
2. Pinch bolt

4. Loosen the front fork pinch bolts and remove the cap bolts from the inner fork tubes.

5. Place an open container under each drain hole. Remove the drain screw from each outer tube.

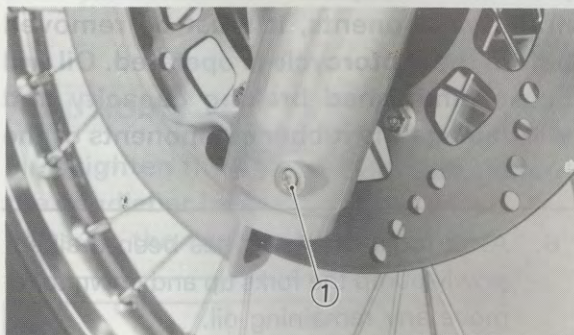

1. Drain screw

E

WARNING:

Do not let oil contact the disc brake components. If any oil should contact the brake components, it must be removed before the motorcycle is operated. Oil will cause diminished braking capacity and will damage the rubber components of the brake assembly.

6. After most of the oil has been drained, slowly pump the forks up and down to remove any remaining oil.
7. Inspect the drain screw gasket. Replace if damaged. Reinstall the drain screws.
8. Pour the specified amount of oil into each fork inner tube.

Front fork oil capacity (each fork):

537 cm³ (18.9 Imp oz, 18.2 US oz)

Recommended oil:

Fork oil 10W or equivalent

9. After filling, slowly pump the forks up and down to distribute the oil.
10. Inspect the O-ring on the cap bolt. Replace if damaged.



1. Cap bolt

2. O-ring

11. Reinstall the cap bolt.

Tightening torque:

Cap bolt:

23 Nm (2.3 m•kg, 17 ft•lb)

12. If the air valve does not face as shown, loosen the pinch bolts on the under bracket and reset the forks in the following procedure:

- a. Level the top of the inner fork tube with the top of the steering crown.
- b. Face the air valve as shown.

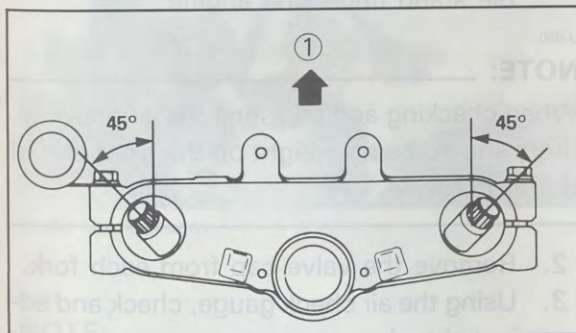

1. Forward

13. Tighten the front fork pinch bolts and install the handlebars.

U-070

NOTE: _____

The upper handlebar holder should be installed with the punched mark forward.

U-367

CAUTION: _____

First tighten the bolts on the front side of the handlebar holder, and then tighten the bolts on the rear side.

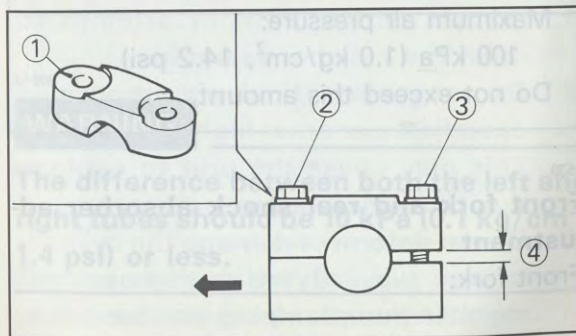

1. Punched mark 2. 1st 3. 2nd 4. Gap

E

Tightening torque:

Front fork pinch bolt:

23 Nm (2.3 m•kg, 17 ft•lb)

Handlebar installation bolt:

20 Nm (2.0 m•kg, 15 ft•lb)

14. Fill the fork with air using an air pump or pressurized air supply. Refer to "Front fork and rear shock absorber adjustment" for proper air pressure adjusting.

Maximum air pressure:100 kPa (1.0 kg/cm², 14.2 psi)

Do not exceed this amount.

I-539

Front fork and rear shock absorber adjustment

Front fork:

U-669

WARNING:

Always adjust each fork preload to the same setting. Uneven adjustment can cause poor handling and loss of stability.

1. Elevate the front wheel by placing a suitable stand under the engine.

U-050

NOTE:

When checking and adjusting the air pressure, there should be no weight on the front end of the motorcycle.

2. Remove the valve cap from each fork.
3. Using the air check gauge, check and adjust the air pressure.

If the air pressure is increased, the suspension becomes stiffer, and if decreased, it becomes softer.

To increase:
Use an air pump or pressurized air supply.
To decrease:
Release the air by pushing the valve.

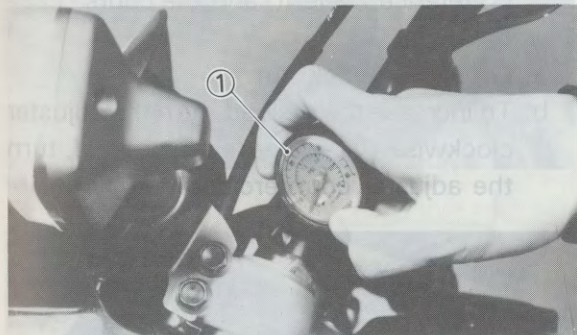

1. Air check gauge

U-051

NOTE:

An optional air check gauge is available. Please ask a nearby Yamaha dealer.

P/No. 2X4-2811A-00

Standard air pressure:
0 kPa (0 kg/cm², 0 psi)
Maximum air pressure:
100 kPa (1.0 kg/cm², 14.2 psi)

U-334

CAUTION:

Never exceed the maximum pressure, or oil seal damage may occur.

U-665

WARNING:

The difference between both the left and right tubes should be 10 kPa (0.1 kg/cm², 1.4 psi) or less.

4. Install the valve caps securely.

Rear shock (Monocross suspension "De Carbon" system)

U-673

WARNING:

E This shock absorber contains highly pressurized nitrogen gas. Read and understand the following information before handling the shock absorber. The manufacturer cannot be held responsible for property damage or personal injury that may result from improper handling.

1. Do not tamper with or attempt to open the cylinder assembly.
2. Do not subject shock absorber to an open flame or other high heat source. This may cause the unit to explode due to excessive gas pressure.
3. Do not deform or damage the cylinder in any way. Cylinder damage will result in poor damping performance.
4. Bring your shock absorber to a Yamaha dealer for any service.

Rear shock absorber adjustment

1. Spring

The spring preload of the rear shock absorber can be adjusted to suit rider's preference, weight, and the course conditions.

- a. Loosen the lock nut.
- b. To increase the preload, turn the adjuster clockwise. To decrease the preload, turn the adjuster counterclockwise.

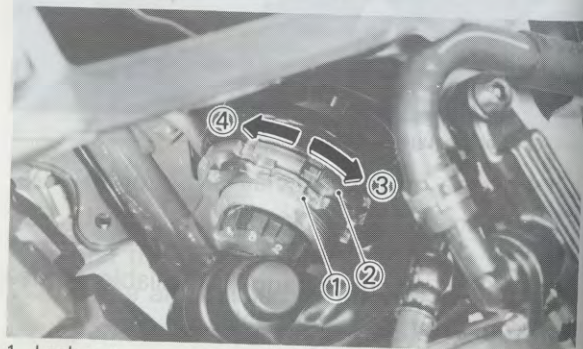

1. Lock nut
2. Adjuster
3. Increase spring preload
4. Decrease spring preload

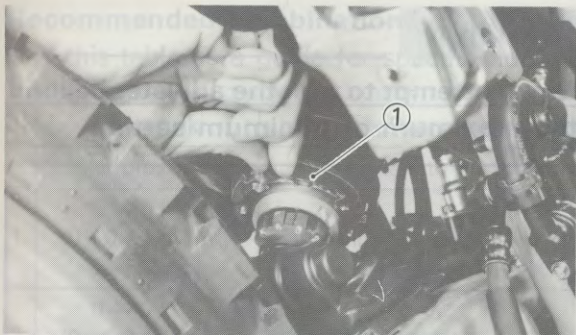

1. Special wrench

U-363

CAUTION: _____

Never attempt to turn the adjuster beyond the maximum or minimum setting.

- c. The length of the spring (installed) changes 1 mm (0.04 in) per turn of the adjuster.

S.T.D. Length	239 mm (9.4 in)
MIN. Length	226.5 mm (8.9 in)
MAX. Length	247.5 mm (9.7 in)

U-052

NOTE: _____

When adjusting, use the special wrench which is included in the owner's tool kit.

Tightening torque:
70 Nm (7.0 m•kg, 50 ft•lb)

U-364

CAUTION: _____

Always tighten the lock nut against the spring adjuster and torque the lock nut to specification.

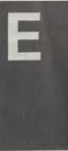

2. Damping

- a. Turn the damping adjuster to increase or decrease the damping.
- b. If the damping adjuster is turned toward the "5", the damping becomes harder; if the adjuster is turned toward the "1", damping becomes softer.

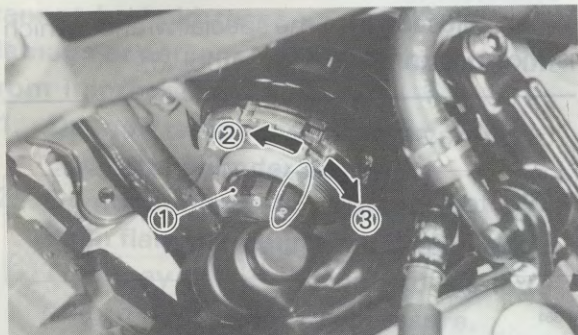

1. Damping adjuster 2. Decrease 3. Increase

	Hard		STD	Soft	
Adjusting position	5	4	3	2	1

CAUTION:

Never attempt to turn the adjuster beyond the maximum or minimum setting.

Recommended combinations of the front fork and the rear shock absorber settings

Use this table as a guide for specific riding and motorcycle load conditions.

	Front fork	Rear shock absorber		Loading condition	
		Spring length	Damping adjuster	Solo rider	With passenger
1.	0~40 kPa (0~0.4 kg/cm ² , 0~5.7 psi)	239 mm (9.4 in)	1~3	○	
2.	0~40 kPa (0~0.4 kg/cm ² , 0~5.7 psi)	244 mm (9.6 in)	4~5		○

E



Steering inspection

Periodically inspect the condition of the steering. Worn out or loose steering bearings may be dangerous.

Place a block under the engine to raise the front wheel off the ground.

Hold the lower end of the front forks and try to move them forward and backward. If any free play can be felt, ask a Yamaha dealer to inspect and adjust the steering. Inspection is easier if the front wheel is removed.

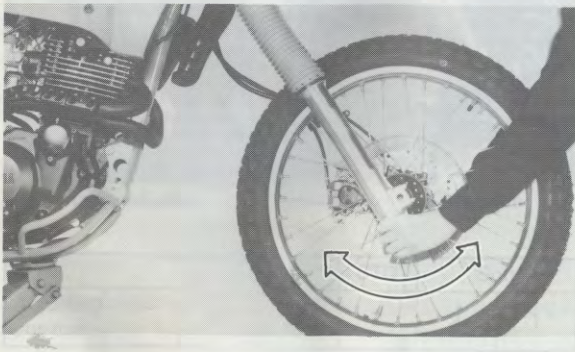

WARNING:

Securely support the motorcycle so there is no danger of it falling over.

Wheel bearings

If the wheel bearings in the front or rear wheel allow play in the wheel hub or if the wheel does not turn smoothly, have a Yamaha dealer inspect the wheel bearings. The wheel bearings should be inspected according to the Maintenance Schedule.

Battery

Check the level of the battery electrolyte and see that the terminals are tight. Add distilled water if the electrolyte level is low.

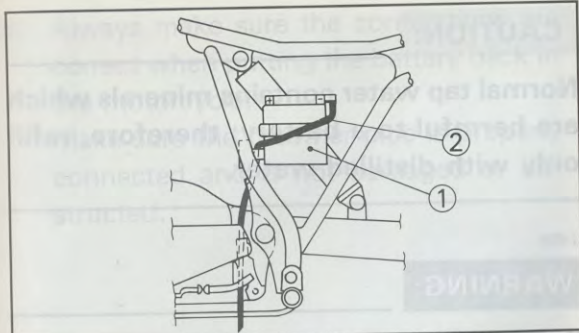

1. Battery 2. Battery breather pipe

U-336

CAUTION:

When inspecting the battery, be sure the breather pipe is routed correctly. If the breather pipe touches the frame or exits in such a way as to cause battery electrolyte or gas to exit onto the frame, structural and cosmetic damage to the motorcycle can occur.

WARNING:

Battery electrolyte is poisonous and dangerous, causing severe burns, etc. It contains sulfuric acid. Avoid contact with skin, eyes or clothing.

Antidote: **EXTERNAL**-Flush with water. **INTERNAL**-Drink large quantities of water or milk. Follow with milk of magnesia, beaten egg, or vegetable oil. Call a physician immediately.

Eyes: Flush with water for 15 minutes and get prompt medical attention. Batteries produce explosive gases. Keep sparks, flame, cigarettes etc., away. Ventilate when charging or using in an enclosed space. Always shield your eyes when working near batteries.

KEEP OUT OF REACH OF CHILDREN.

Replenishing the battery fluid

A poorly maintained battery will deteriorate quickly. The battery fluid should be checked at least once a month.

1. The level should be between the upper and lower level marks. Use only distilled water if refilling is necessary.

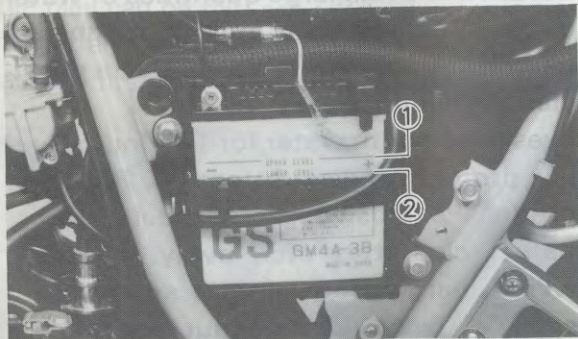

1. Upper level

2. Lower level

CAUTION:

Normal tap water contains minerals which are harmful to a battery; therefore, refill only with distilled water.

WARNING:

Battery fluid on the chain can cause premature failure and possibly an accident.

2. When the motorcycle will not be used for a month or longer, remove the battery and store it in a cool, dark place. Completely recharge the battery before reusing.
3. If the battery will be stored for a longer period than the above, check the specific gravity of the fluid at least once a month and recharge the battery when it is too low.

4. Always make sure the connections are correct when putting the battery back in the motorcycle.

Make sure the breather pipe is properly connected and is not damaged or obstructed.

I-910

Fuse replacement

If a fuse is blown, turn off the ignition switch and the switch in the circuit in question. Install a new fuse of proper amperage.

Turn on the switches, and see if the electrical device operates. If the fuse immediately blows again, consult a Yamaha dealer.

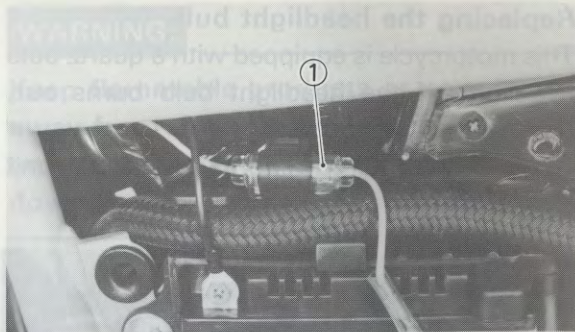

1. Fuse

U-344

CAUTION:

Do not use fuses of higher amperage rating than those recommended. Substitution of a fuse of improper rating can cause extensive electrical system damage and possibly a fire.

Replacing the headlight bulb

This motorcycle is equipped with a quartz bulb headlight. If the headlight bulb burns out, replace the bulb as follows:

1. Remove the cowling and headlight unit assembly.

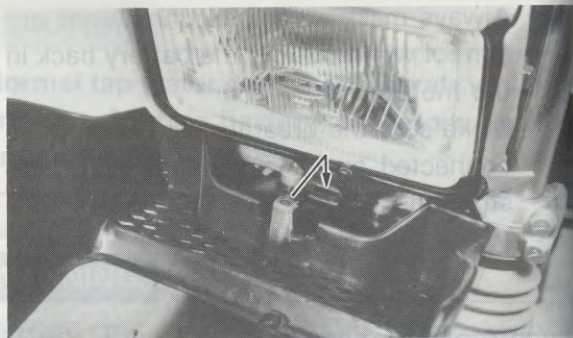

2. Disconnect the lead wires, and remove the cover.

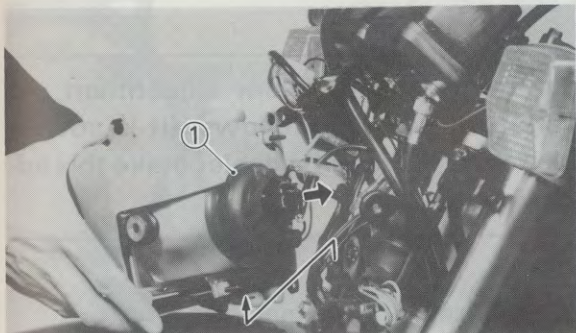

1. Cover

3. Turn the bulb holder counterclockwise and remove the defective bulb.

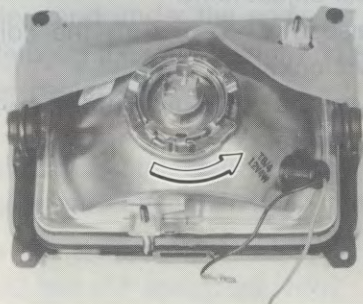

U-660

WARNING:

Keep flammable products or your hands away from the bulb while it is on, it will be hot. Do not touch the bulb until it cools down.

4. Slip a new bulb into position and secure it in place with the bulb holder.

U-341

CAUTION:

Avoid touching the glass part of the bulb. Keep it free from oil; otherwise, the transparency of the glass, life of the bulb, and illuminous flux will be adversely affected. If oil gets on the bulb, thoroughly clean it with a cloth moistened with alcohol or lacquer thinner.

E

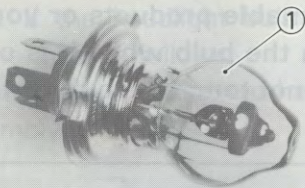

1. Don't touch

5. Reinstall the light unit assembly and cowl-
ing. Adjust the headlight beam if
necessary.

1-809

Headlight beam adjustment

U-343

CAUTION:

For the headlight beam adjustment, be
sure to proceed as follows; (It is advisa-
ble to have a Yamaha dealer make this ad-
justment.)

1. Horizontal adjustment:

To adjust the beam to the left, turn the
adjusting screw clockwise.

To adjust the beam to the right, turn the
screw counterclockwise.

2. Vertical adjustment:

To raise the beam, turn the adjusting
screw clockwise.

To lower the beam, turn the screw coun-
terclockwise.

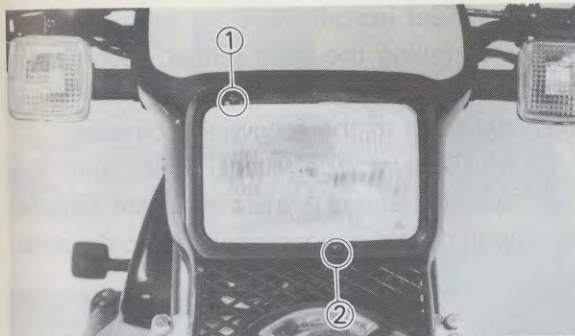

1. Horizontal adjusting screw 2. Vertical adjusting screw

J-232

Front wheel removal

1. Elevate the front wheel by placing a suitable stand under the engine.
2. Remove the wire holder and speedometer cable.

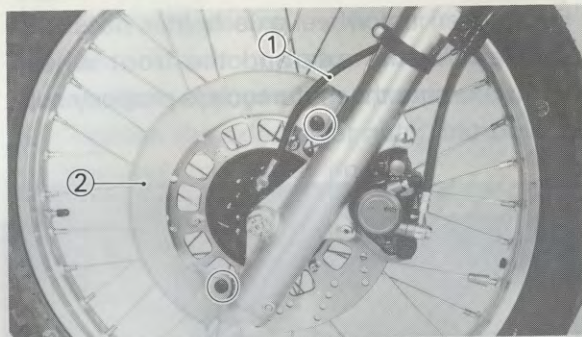

1. Speedometer cable 2. Disc cover

3. Remove the disc cover.
4. Remove the cotter pin and wheel axle nut.

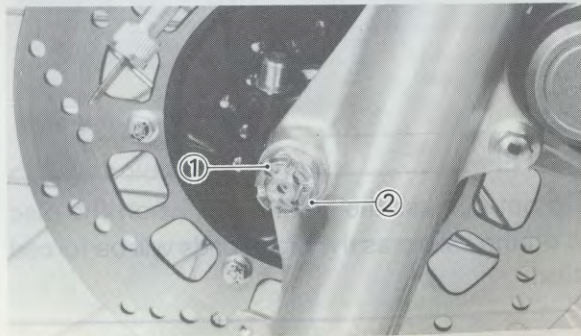

1. Cotter pin 2. Axle nut

E

5. Loosen the wheel axle holder nuts.
6. Remove the axle and the front wheel. Make sure the motorcycle is properly supported.

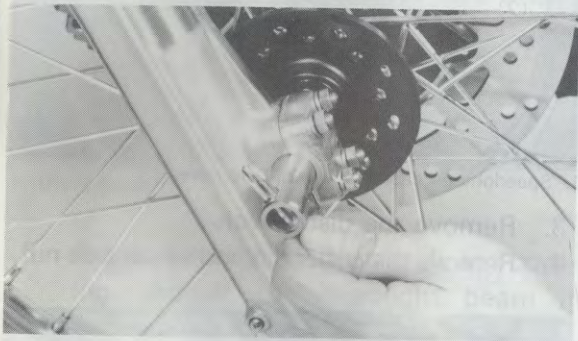

U-054

NOTE:

Do not depress the brake lever when the disc is off the caliper as the brake pads will be forced shut.

J-216

Front wheel installation

When installing the front wheel, reverse the removal procedure.

Pay attention to the following points:

1. Make sure the wheel hub and the speedometer clutch assembly are installed with the projections meshed into the slots.

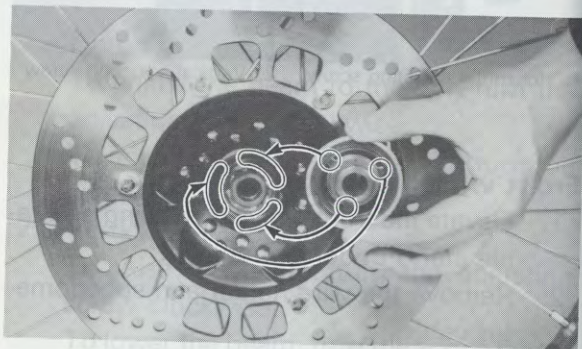

2. Make sure the projecting portion (torque stopper) of the speedometer housing is positioned correctly.

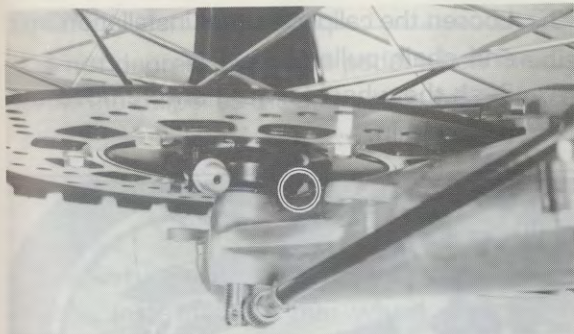

3. Make sure the axle nut is properly torqued, and a new cotter pin is installed.

U-647

WARNING:

Always use a new cotter pin on the axle nut.

Axle nut torque:

110 Nm (11 m•kg, 80 ft•lb)

4. Before tightening the holder nuts, compress the front forks several times to check for proper fork operation.
5. Tighten the axle holder nuts; first the upper and then lower ones.

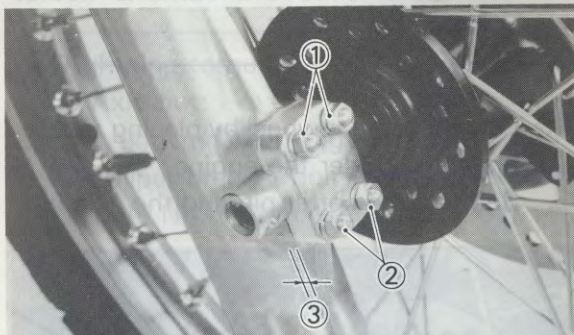

1. 1st

2. 2nd

3. Gap

Axle holder nut torque:

8 Nm (0.8 m•kg, 6 ft•lb)

Rear wheel removal

U-662

WARNING:

It is advisable to have a Yamaha dealer service the rear wheel.

1. Elevate the rear wheel by placing a suitable stand under the engine.
2. Remove the cotter pin and the axle nut.

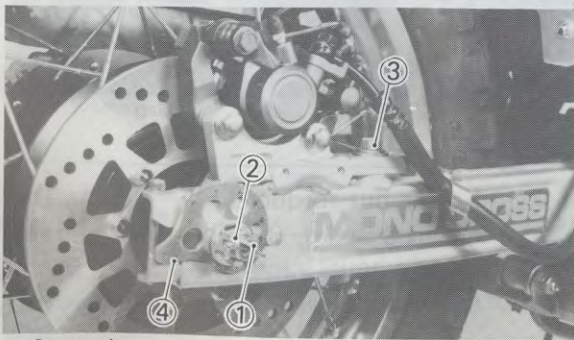

1. Cotter pin
2. Axle nut
3. Caliper bracket installation bolt
4. Chain puller

3. Loosen the caliper bracket installation bolt and chain pullers.
4. Push the wheel forward and remove the drive chain.

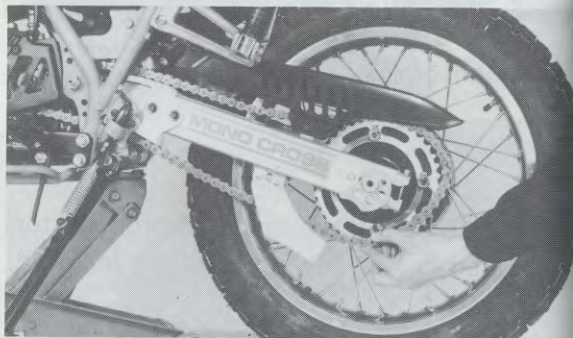

5. Pull out the rear axle and remove the wheel assembly backward.

NOTE: _____

Do not depress the brake pedal when the disc is off the caliper as the brake pads will be forced shut.

J-359K

Rear wheel installation

When installing the rear wheel, reverse the removal procedure. Pay attention to the following points:

1. Make sure the rear wheel axle is inserted on the left-hand side and that the chain pullers are installed with the punched side outward.
2. Adjust the drive chain.
3. Make sure the axle nut and caliper bracket installation bolt are properly torqued, and a new cotter pin is installed.

WARNING: _____

Always use a new cotter pin on the axle nut.

Tightning torque:

Axle nut:

90 Nm (9.0 m•kg, 65 ft•lb)

Caliper bracket bolt:

45 Nm (4.5 m•kg, 33 ft•lb)

Troubleshooting

Although Yamaha motorcycles receive a rigid inspection before shipment from the factory, trouble may occur during operation. Any problem in the fuel, compression, or ignition systems can cause poor starting and a loss of power. The troubleshooting chart describes a quick, easy procedure for checking these systems.

If your motorcycle requires any repair, bring it to a Yamaha dealer. The skilled technicians at a Yamaha dealer have the tools, experience, and know-how to properly service your motorcycle. Use only genuine Yamaha parts on your motorcycle. Imitation parts may look like Yamaha parts, but they are often inferior. Consequently, they have a shorter service life and can lead to expensive repair bills.

Troubleshooting chart

U-663

WARNING:

Never check the fuel system while smoking or in the vicinity of an open flame.

1. Fuel

Check if there is fuel in the fuel tank

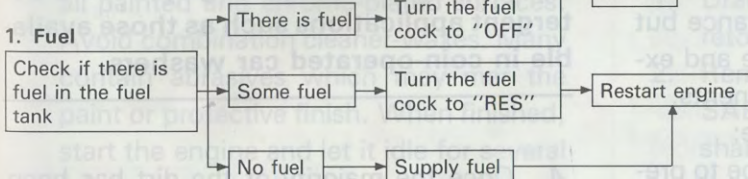

2. Compression

Kick the kick lever to see if there is compression

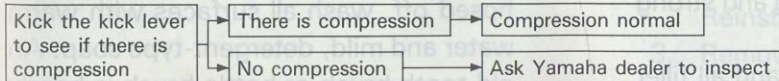

3. Ignition

Remove plug and check electrode

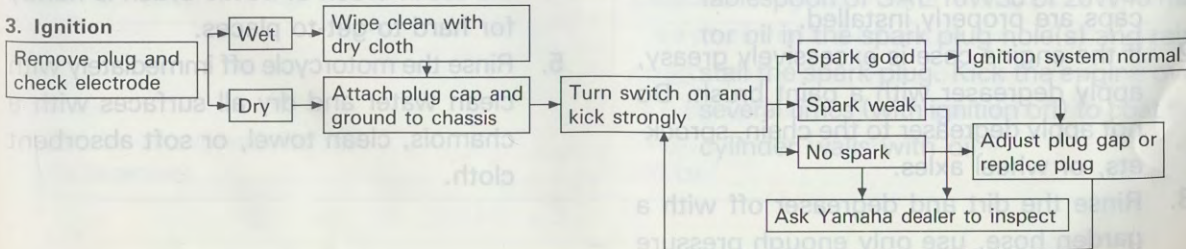

CLEANING AND STORAGE

K-009

A. CLEANING

Frequent thorough cleaning of your motorcycle will not only enhance its appearance but will improve its general performance and extend the useful life of many components.

1. Before cleaning the motorcycle:
 - a. Block off the end of exhaust pipe to prevent water entry; a plastic bag and strong rubber band may be used.
 - b. Make sure the spark plug(s) and all filler caps are properly installed.
2. If the engine case is excessively greasy, apply degreaser with a paint brush. Do not apply degreaser to the chain, sprockets, or wheel axles.
3. Rinse the dirt and degreaser off with a garden hose, use only enough pressure to do the job.
4. Once the majority of the dirt has been hosed off, wash all surfaces with warm water and mild, detergent-type soap. An old tooth brush or bottle brush is handy for hard-to-get-to places.
5. Rinse the motorcycle off immediately with clean water and dry all surfaces with a chamois, clean towel, or soft absorbent cloth.

CAUTION:

Excessive hose pressure may cause water seepage and contamination of wheel bearings, front forks, brakes and transmission seals. Many expensive repair bills have resulted from improper high pressure detergent applications such as those available in coin-operated car washers.

6. Dry the chain and lubricate it to prevent rust.
7. Clean the seat with a vinyl upholstery cleaner to keep the cover pliable and glossy.
8. Automotive-type wax may be applied to all painted and chrome-plated surfaces. Avoid combination cleaner-waxes. Many contain abrasives which may mar the paint or protective finish. When finished, start the engine and let it idle for several minutes.

B. STORAGE

Long term storage (60 days or more) of your motorcycle will require some preventive procedures to guard against deterioration. After thoroughly cleaning the motorcycle, prepare for storage as follows:

1. Drain the fuel tank, fuel lines, and carburetor float bowl(s).
2. Remove empty fuel tank, pour a cup of SAE 10W30 or 20W40 motor oil in tank, shake the tank to coat the inner surfaces thoroughly and drain off the excess oil. Reinstall the tank.
3. Remove the spark plug(s), pour about one tablespoon of SAE 10W30 or 20W40 motor oil in the spark plug hole(s) and reinstall the spark plug. Kick the engine over several times (with ignition off) to coat the cylinder walls with oil.

4. Remove the drive chain. Thoroughly clean the chain with kerosene and lubricate. Reinstall the chain or store it in a plastic bag (tied to frame for safe-keeping).
5. Lubricate all control cables.
6. Block up the frame to raise both wheels off the ground.
7. Tie a plastic bag over the exhaust pipe outlet to prevent moisture from entering.
8. If storing in a humid or salt-air atmosphere, coat all exposed metal surfaces with a light film of oil. Do not apply oil to any rubber parts or the seat cover.
9. Remove the battery and charge it. Store it in a dry place and recharge it once a month. Do not store the battery in an excessively warm or cold place (less than 0°C(30°F) or more than 30°C(90°F)).

NOTE: _____

Make any necessary repairs before storing the motorcycle.

4. Once the majority of the dirt has been hosed off, wash all surfaces with warm water and mild, detergent-type soap. An old tooth brush or bottle brush is handy for hard-to-get-to places.
5. Rinse the motorcycle off immediately with clean water and dry all surfaces with a chamois, clean towel, or soft absorbent cloth.

SPECIFICATIONS

(F): For France (G): For Germany (Sw): For Sweden
 (E): For England (H): For Holland (Gr): For Greece
 (B): For Belgium (N): For Norway (D): For Denmark

Type/manufacturer	Model	Y27PV/TEIKEI	XT600
Dimension:			
Overall length		2,210 mm (87.0 in) (F) (E) (H) (B)	2,290 mm (90.2 in) (G) (Sw) (N) (D)
Overall width		885 mm (34.8 in)	
Overall height		1,230 mm (48.4 in)	
Seat height		885 mm (34.8 in)	
Wheel base		1,440 mm (56.7 in) (2KF)	1,435 mm (56.5 in) (2NF)
Minimum ground clearance		265 mm (10.4 in)	
Basic weight:			
With oil and full fuel tank		153 kg (337 lb)	
Minimum turning radius:		2,200 mm (86.6 in)	
Engine:			
Type		Air cooled 4-stroke, gasoline SOHC	
Model		2KF (F)(G)(Sw)(E)(H)(Gr)(B)(N)(D), 2NF (G)	
Cylinder arrangement		Single cylinder Forward inclined	
Displacement		595 cm ³	

E

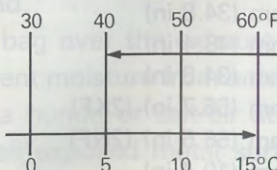
Model	XT600
Bore × Stroke Compression ratio Starting system Lubrication system	95 × 84 mm (3.74 × 3.31 in) 8.5 : 1 Kick starter Dry sump
Engine oil (4-cycle): Type  Capacity Periodic oil change With oil filter replacement Total amount Oil tank	SAE 20W40 type SE motor oil (If temperature does not go below 5°C/40°F) See page 4-4 SAE 10W30 type SE motor oil (If temperature does not go above 15°C/60°F)
Air filter:	Wet type element
Fuel: Type Tank capacity Reserve amount	Regular gasoline 13.0 L (2.9 Imp gal, 3.4 US gal) 2.0 L (0.4 Imp gal, 0.5 US gal)

Model	XT600	
Carburetor: Type/manufacturer	Y27PV/TEIKEI	
Spark plug: Type/manufacturer Gap	DPR7EA-9 or DPR8EA-9/NGK 0.8 ~ 0.9 mm (0.031 ~ 0.035 in)	DR7ES/NGK 0.6 ~ 0.7 mm (0.024 ~ 0.028 in)
Clutch type:	Wet, multi-disc	
Transmission: Primary reduction system Primary reduction ratio Secondary reduction system Secondary reduction ratio Transmission type Operation Gear ratio: 1st 2nd 3rd	Spur gear 74/31 (2.387) Chain drive 39/15 (2.600) (2KF) 40/15 (2.667) (2NF) Constant mesh 5-speed Left foot operation 31/12 (2.583) 27/17 (1.588) 24/20 (1.200)	



E

Model	XT600
4th Stroke	21/22 (0.955)
5th	19/24 (0.792)
Chassis:	
Frame type	Diamond
Caster angle	27°15' (F)(G)(Sw)(E)(H)(Gr)(B)(N)(D) 27°05' (G)
Trail	109 mm (4.3 in) (F)(G)(Sw)(E)(H)(Gr)(B)(N)(D) 107 mm (4.2 in) (G)
Tire:	
Type	With tube
Size — Front	3.00S21-4PR
Rear	4.60S18-4PR (F)(G)(Sw)(E)(H)(Gr)(B)(N)(D) 4.00S18-4PR (G)
Brake:	
Front brake type	Single, Disk brake
Operation	Right hand operation
Rear brake type	Single Disk brake
Operation	Right foot operation
Suspension:	
Front	Telescopic fork
Rear	Swing arm (Monocross suspension)

Model	XT600
Shock Absorber: Front Rear	Air Coil spring, Oil damper Gas, Coil spring, Oil damper
Wheel travel: Front Rear	255 mm (10.0 in) 235 mm (9.3 in)
Electrical: Ignition system Generator system Battery type/capacity	CDI magneto , AC generator GM4A-3B/FB4L-B/12V 4AH
Headlight type:	Quarz bulb
Bulb wattage/quantity: Headlight Tail/brake light Flasher light Auxiliary light Meter light	60W/55W 21W/5W 21W × 4 4W, 3.4W (E) 3.4W × 2

E

E

Model	XT600
Indicator light wattage/quantity: "NEUTRAL"	3.4W
"HIGH BEAM"	3.4W
"TURN"	3.4W
Front wheel level	27° 15' (F)(G)(Sw)(E)(H)(Gr)(B)(N)(D)
Rear wheel level	27° 50' (G)
Front wheel offset	109 mm (4.3 in)
Rear wheel offset	107 mm (4.2 in)
Ignition system	Generator system
Generator system	Generator system
Battery type/capacity	With tube
Headlight wattage/quantity	4.60S18-4PR (F)(G)(Sw)(E)(H)(Gr)(B)(N)(D)
Headlight	4.00S18-4PR (G)
Tail/brake light	Single Disk, single
Fleasher light	Right hand operation
Auxiliary light	Single Disk brake
Meter light	Right foot operation
Suspension	Telescopic fork
Front	Swing arm (Monocross suspension)
Rear	

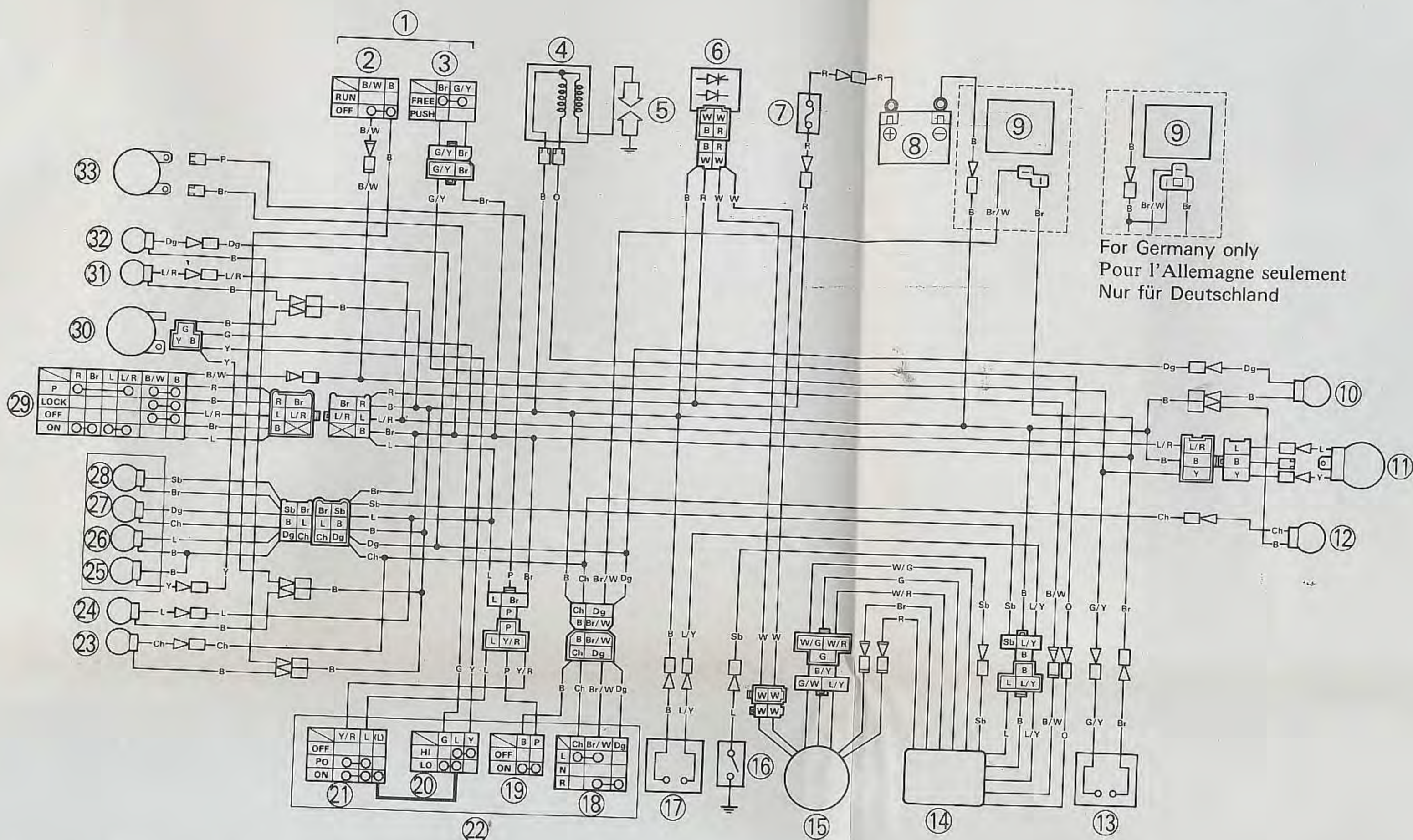

For Germany only
 Pour l'Allemagne seulement
 Nur für Deutschland

- 1. Handlebar switch (R)
- 2. "ENGINE STOP" switch
- 3. Front brake switch
- 4. Ignition coil
- 5. Spark plug
- 6. Rectifier/Regulator
- 7. Fuse
- 8. Battery
- 9. Flasher relay
- 10. Rear flasher light (R)
- 11. Tail/Brake light
- 12. Rear flasher light (L)
- 13. Rear brake switch
- 14. C.D.I. unit
- 15. C.D.I. magneto
- 16. Neutral switch
- 17. Sidestand switch
- 18. Handlebar switch (L)
- 19. "TURN" switch
- 20. "HORN" switch
- 21. "LIGHTS" (Dimmer) switch
- 22. "LIGHTS" switch
- 23. Front flasher light (L)
- 24. Speedometer light
- 25. "HIGH BEAM" indicator light
- 26. Tachometer light
- 27. "TURN" indicator light
- 28. "NEUTRAL" indicator light
- 29. Main switch
- 30. Headlight
- 31. Auxiliary light
- 32. Front flasher light (R)
- 33. Horn

- 1. Commutateur sur guidon (D)
- 2. Coupe-circuit de sécurité "ENGINE STOP"
- 3. Contacteur avant du feu stop
- 4. Bobine d'allumage
- 5. Bougie
- 6. Redresseur/Régulateur
- 7. Fusible
- 8. Batterie
- 9. Relais des clignotants
- 10. Clignoteur arrière (D)
- 11. Feu arrière/stop
- 12. Clignoteur arrière (G)
- 13. Contacteur arrière du feu stop
- 14. Bloc C.D.I.
- 15. Magnéto C.D.I.
- 16. Contacteur de point mort
- 17. Contacteur de la béquille latérale
- 18. Commutateur sur guidon (G)
- 19. Commutateur de clignotant "TURN"
- 20. Bouton d'avertisseur "HORN"
- 21. Commutateur de feu de route/feu de croisement "LIGHTS"
- 22. Commutateur d'éclairage "LIGHTS"
- 23. Clignoteur avant (G)
- 24. Lampe d'indicateur de vitesse
- 25. Lampe-témoin de feu de route "HIGH BEAM"
- 26. Lampe de compte-tours
- 27. Lampe-témoin de clignotant "TURN"
- 28. Lampe-témoin de point mort "NEUTRAL"
- 29. Contacteur à clé
- 30. Phare
- 31. Témoin auxiliaire
- 32. Clignoteur avant (D)
- 33. Avertisseur

- 1. Lenkerschalter (R)
- 2. Motorstoppschalter „ENGINE STOP“
- 3. Vorderrad-Bremslichtschalter
- 4. Zündspule
- 5. Zündkerze
- 6. Gleichrichter/ Spannungsregler
- 7. Sicherung
- 8. Batterie
- 9. Blinkerrelais
- 10. Hinterer Blinklicht (R)
- 11. Schluß/ Bremsleuchte
- 12. Hinterer Blinklicht (L)
- 13. Hinterrad-Bremslichtschalter
- 14. C.D.I.-Einheit
- 15. C.D.I.-Magnetzünder
- 16. Leerlaufschalter
- 17. Seitenständerschalter
- 18. Lenkerschalter (L)
- 19. Blinkerschalter „TURN“
- 20. Signalhornschalter „HORN“
- 21. Abblendlichtschalter „LIGHTS“
- 22. Lichtschalter „LIGHTS“
- 23. Vorderer Blinklicht (L)
- 24. Geschwindigkeitsmesserlampe
- 25. Fernlicht-Kontrolllampe „HIGH BEAM“
- 26. Drehzahlmesserlampe
- 27. Blinkerkontrollleuchte „TURN“
- 28. Leerlauf-Kontrolllampe „NEUTRAL“
- 29. Hauptschalter
- 30. Scheinwerfer
- 31. Zusatzleuchte
- 32. Vorderer Blinklicht (R)
- 33. Signalhorn

COLOR CODE

- B Black
- Br Brown
- Ch Chocolate
- Dg Dark green
- G Green
- L Blue
- O Orange
- P Pink
- R Red
- Sb Sky blue
- W White
- Y Yellow
- B/W Black/White
- B/Y Black/Yellow
- Br/W Brown/White
- G/W Green/White
- G/Y Green/Yellow
- L/R Blue/Red
- L/Y Blue/Yellow
- W/R White/Red
- W/G White/Green
- Y/R Yellow/Red

CODE DE COULEUR

- B Noir
- Br Brun
- Ch Chocolat
- Dg Vert foncé
- G Vert
- L Bleu
- O Orange
- P Rose
- R Rouge
- Sb Bleu ciel
- W Blanc
- Y Jaune
- B/W Noir/Blanc
- B/Y Noir/Jaune
- Br/W Brun/Blanc
- G/W Vert/Blanc
- G/Y Vert/Jaune
- L/R Bleu/Rouge
- L/Y Bleu/Jaune
- W/R Blanc/Rouge
- W/G Blanc/Vert
- Y/R Jaune/Rouge

FARBENKODIERUNG

- B Schwarz
- Br Braun
- Ch Schokoladefarbig
- Dg Dunkelgrün
- G Grün
- L Blau
- O Orange
- P Rosa
- R Rot
- Sb Himmelblau
- W Weiß
- Y Gelb
- B/W Schwarz/Weiß
- B/Y Schwarz/Gelb
- Br/W Braun/Weiß
- G/W Grün/Weiß
- G/Y Grün/Gelb
- L/R Blau/Rot
- L/Y Blau/Gelb
- W/R Weiß/Rot
- W/G Weiß/Grün
- Y/R Gelb/Rot